



**UM2619**

**N1419 Programmable HV Power Supply**

**Rev. 5 - 22 June 2014**

## Purpose of this Manual

This document is the N1419 User's Manual; it contains information about the installation, the configuration and the use of the Power Supply System.

## Change Document Record

Date	Revision	Changes
30 May 2012	Rev. 0	Internal use
30 November 2012	Rev. 1	Preliminary
22 March 2013	Rev. 2	Polarity change instructions update
4 April 2014	Rev. 3	Ground specs
22 July 2014	Rev. 4	Technical specs
22 June 2015	Rev. 5	HV Channel Output updated

## Symbols, abbreviated terms and notation

T.B.D.

## Reference Documents

T.B.D.

### Disclaimer

No part of this manual may be reproduced in any form or by any means, electronic, mechanical, recording, or otherwise, without the prior written permission of CAEN SpA.

CAEN will repair or replace any product within the guarantee period if the Guarantor declares that the product is defective due to workmanship or materials and has not been caused by mishandling, negligence on behalf of the User, accident or any abnormal conditions or operations.

CAEN declines all responsibility for damages or injuries caused by an improper use of the Modules due to negligence on behalf of the User. It is strongly recommended to read thoroughly the CAEN User's Manual before any kind of operation. *CAEN reserves the right to change partially or entirely the contents of this Manual at any time and without giving any notice.*

**Disposal of the Product** *The product must never be dumped in the Municipal Waste. Please check your local regulations for disposal of electronics products.*

**Made In Italy** : We stress the fact that all the boards are made in Italy because in this globalized world, where getting the lowest possible price for products sometimes translates into poor pay and working conditions for the people who make them, at least you know that who made your board was reasonably paid and worked in a safe environment. (this obviously applies only to the boards marked "made in italy", we cannot attest to the manufacturing process of "third party" boards).

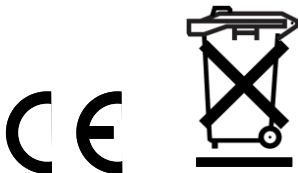

# Index

<b>1. General description .....</b>	<b>6</b>
Overview .....	6
<b>2. Technical specifications .....</b>	<b>7</b>
Packaging .....	7
Power requirements .....	7
Front and back panel .....	9
Front panel connections .....	11
Local control section .....	11
Channel control section .....	11
HV Status control section .....	12
Alarm signal .....	12
Interlock signal.....	12
Remote communication control section .....	13
Rear panel connections .....	14
HV Channel Output .....	14
Imon Zoom.....	14
Technical specifications table .....	15
<b>3. Operating modes.....</b>	<b>16</b>
Programmable parameters.....	16
Boards parameters.....	16
Channel settings.....	17
Local Control .....	18
HV connection.....	18
Module settings .....	19
Channel settings.....	20
Group Settings .....	22
Smileys.....	24
Current monitor offset calibration .....	24
Remote Control .....	25
Serial Links.....	25
USB communication .....	25
RS232 communication .....	25
RS485 communication .....	26
Ethernet communication .....	26
Communication Control.....	27
Remote Control: Main Menu.....	27
Remote Control: General Menu .....	28
Remote Control: Channels Menu .....	28
Remote Control: firmware upgrade.....	29
Remote Control: format EEPROM .....	30
Remote Control: Current offset calibration .....	30
USB - RS485 Communication Protocol .....	31
Command Format .....	31
Format of response string .....	31
MONITOR commands related to the Channels .....	31
Meaning of STATUS bits (value read in decimal Format).....	32
MONITOR commands related to the module .....	33
Meaning of Board Alarm bits.....	34
SET commands related to the Channels.....	34
SET commands related to the module .....	34
<b>4. Internal Settings .....</b>	<b>35</b>
Polarity selection .....	35
Internal switches.....	37
Local Bus termination .....	37
RS485 – RS232 conversion .....	37
Grounding specifications .....	37
Safety Earth connection .....	38

## List of Figures

Fig. 1: Mod. 1419 series N1419 Programmable HV Power Supply .....	6
Fig. 2: Backplane NIM connector .....	8
Fig. 3: Mod. N1419 series front panel (std., A, B) .....	9
Fig. 4: Mod. N1419 series back panel (std., A, B) .....	10
Fig. 5: Local control panel .....	11
Fig. 6: Channel control panel and Kill scheme .....	11
Fig. 7: N1419 HV Status control panel .....	12
Fig. 8: N1419 ALARM electrical scheme .....	12
Fig. 9: N1419 ALARM TTL configured .....	12
Fig. 10: N1419 INTERLOCK electrical scheme .....	12
Fig. 11: Remote communication control and RS485 I/O – RS232 IN electrical scheme .....	13
Fig. 12: HV Channel panel and test point electrical scheme .....	14
Fig. 13: Welcome screen .....	18
Fig. 14: Channel OFF status screen .....	18
Fig. 15: Channel ON status screen .....	18
Fig. 16: Channel KILL status screen .....	18
Fig. 17: Mode settings status screen .....	19
Fig. 18: Mode settings access screen .....	19
Fig. 19: Mode settings edit screen .....	19
Fig. 20: Channel settings edit screen .....	20
Fig. 21: Channel VSET select screen .....	20
Fig. 22: Channel VSET access screen .....	20
Fig. 23: Channel VSET digit selection screen .....	20
Fig. 24: Channel VSET digit access screen .....	21
Fig. 25: Channel VSET digit adjust screen .....	21
Fig. 26: Channel VSET digit confirm screen .....	21
Fig. 27: Channel VSET confirm screen .....	21
Fig. 28: Channel VSET de-select screen .....	21
Fig. 29: Channel KILL screen .....	22
Fig. 30: Channel EXIT screen .....	22
Fig. 31: Group selection .....	22
Fig. 32: Group active .....	22
Fig. 33: Group VSET access screen .....	23
Fig. 34: Group VSET digit selection screen .....	23
Fig. 35: Group Channel VSET digit access screen .....	23
Fig. 36: Group VSET digit adjust screen .....	23
Fig. 37: Group VSET digit confirm screen .....	23
Fig. 38: Channel VSET de-select screen .....	24
Fig. 39: Group EXIT screen .....	24
Fig. 40: USB communication diagram .....	25
Fig. 41: RS232 communication diagram .....	25
Fig. 42: RS485 communication diagram .....	26
Fig. 43: Ethernet communication diagram .....	26
Fig. 44: RS232 port cable adapter .....	27
Fig. 45: Main Menu .....	27
Fig. 46: Board Status Menu .....	28
Fig. 47: Channels Menu .....	28
Fig. 48: PC keyboard .....	28
Fig. 49: Channels group setting .....	29
Fig. 50: Firmware Upgrade Menu/1 .....	29
Fig. 51: Firmware Upgrade Menu/2 .....	29
Fig. 52: Format EEPROM Menu .....	30
Fig. 53: Current offset calibration warning .....	30
Fig. 54: Current offset calibration VSET selection .....	30
Fig. 55: Current offset calibration confirmation .....	31
Fig. 56: Side cover removal instructions .....	35
Fig. 57: Polarity selection instructions .....	36
Fig. 58: Dip switch position .....	37
Fig. 59: C21 jumper location .....	38
Fig. 60: Earth configuration connection examples .....	38

## List of Tables

Table 1: Available items.....	6
Table 2: Power requirements .....	7
Table 3: Interlock operation .....	13
Table 4: Mod. N1419 Channel technical specifications .....	15
Table 5: Smileys list .....	24

# 1. General description

## Overview

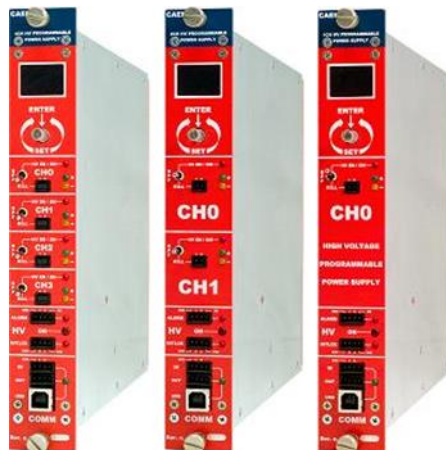

**Fig. 1: Mod. 1419 series N1419 Programmable HV Power Supply**

The Mod. N1419 provides 4 independent High Voltage channels in a single width NIM mechanics. Two and one channel versions (N1419A and N1419B) are also available.

Each channel can provide a  $\pm 500\text{V} / 200 \mu\text{A}$  max output.

Channels have common floating return (common return insulated from the crate ground); HV outputs are delivered through SHV connectors.

The HV output RAMP-UP and RAMP-DOWN rates may be selected independently for each channel in the range 1÷50 V/s in 1 V/s steps.

Safety features include:

- OVERVOLTAGE and UNDERVOLTAGE warning when the output voltage differs from the programmed value by more than 2% of set value (minimum 1V).
- Programmable VMAX protection limit
- OVERCURRENT detection: if a channel tries to draw a current larger than its programmed limit, it enters TRIP status, keeping the maximum allowed value for a programmable time (TRIP), before being switched off
- Channels can be enabled or disabled individually through the Interlock logic.

Module control can take place either locally, assisted by a Graphic color display or remotely, via USB, RS232 or RS485; the RS485 port allows to build a N1419s' daisy chain network (up to 32 modules).

For remote operation, CAEN also provides GECO2020, a graphical application that allows to manage the N14xx HV Power Supplies (as well as all other CAEN Power Supplies).

Moreover, these units can be managed via CAEN HV Wrapper, a set of ANSI C functions bundled in a library, providing the software developer a unified software interface for the control of CAEN Power Supplies. This is a low level application in which the writing of the Control SW is assigned to the user. CAEN HV Wrapper is logically located between an higher level application, such as GECO2020, and the lower layer software libraries. It contains a generic software interface independent by the Power Supply models and by the communication path used to exchange data with them. For more info please visit: [www.caen.it](http://www.caen.it) (products>firmware/software section).

The Mod. A1480 is an optional DC Input Power Equalizer which allows to use a different input power distribution on the N147x modules.

**Table 1: Available items**

Code	Item	Description
WN1419XAAAAA	N1419	4 Channels, local & remote control, NIM HV Power Supply ( $\pm 500\text{V}$ , 200uA, 10nA res.)
WN1419AXAAAA	N1419A	2 Channels, local & remote control, NIM HV Power Supply ( $\pm 500\text{V}$ , 200uA, 10nA res.)
WN1419BXAAAA	N1419B	1 Channel, local & remote control, NIM HV Power Supply ( $\pm 500\text{V}$ , 200uA, 10nA res.)
WA1480XAAAAA	A1480	DC Power Input Equalizer for N147X Family
WPERS0147001	Customization	lmon Zoom x10

## 2. Technical specifications

### Packaging

The Mod. N1419 boards are housed in a single width NIM modules.

### Power requirements

Table 2: Power requirements

Board type	N1419					
Channel configuration	without A1480			with A1480		
	N° ch ON	Current (± 12V)	Current (±6V)	n° ch ON	Current (± 12V)	Current (±6V)
300V/200µA	4 CH	T.B.D.	none	4 CH	T.B.D	T.B.D
500V/20µA	4 CH	T.B.D	none	4 CH	T.B.D	T.B.D
500V/200µA	4 CH	T.B.D	none	4 CH	T.B.D	T.B.D
Board type	N1419A					
Channel configuration	without A1480			with A1480		
	N° ch ON	Current (± 12V)	Current (±6V)	n° ch ON	Current (± 12V)	Current (±6V)
300V/200µA	2 CH	T.B.D	none	2 CH	T.B.D	T.B.D
500V/20µA	2 CH	T.B.D	none	2 CH	T.B.D	T.B.D
500V/200µA	2 CH	T.B.D	none	2 CH	T.B.D	T.B.D
Board type	N1419B					
Channel configuration	without A1480			with A1480		
	N° ch ON	Current (± 12V)	Current (±6V)	n° ch ON	Current (± 12V)	Current (±6V)
300V/200µA	1 CH	T.B.D	none	1 CH	T.B.D	T.B.D
500V/20µA	1 CH	T.B.D	none	1 CH	T.B.D	T.B.D
500V/200µA	1 CH	T.B.D	none	1 CH	T.B.D	T.B.D

**WARNING:** if the A1480 is not installed, ±6V power supplies are not required and power pins 10 and 11 on the backplane NIM connector are not installed (see Fig. 2).

PIN	FUNCTION
1	+3 Volts
2	-3 Volts
3	SPARE
4	RESERVED
5	COAXIAL
6	COAXIAL
7	COAXIAL
8	+200 Volts D.C.
9	SPARE
10	+6 Volts
11	-6 Volts
12	RESERVED
13	CARRY NO. 1
14	SPARE
15	RESERVED
16	+12 Volts
17	-12 Volts
18	SPARE
19	RESERVED
20	SPARE
21	SPARE
22	RESERVED
23	RESERVED
24	RESERVED
25	RESERVED
26	SPARE
27	SPARE
28	+24 Volts
29	-24 Volts
30	SPARE
31	CARRY NO. 2
32	SPARE
33	117 V A.C. (HOT)
34	POWER RET. GND
35	RESET
36	GATE
37	SPARE
38	COAXIAL
39	COAXIAL
40	COAXIAL
41	117 V A.C. (NEUT.)
42	HIGH QUAL. GND
G	GROUND GUIDE PIN

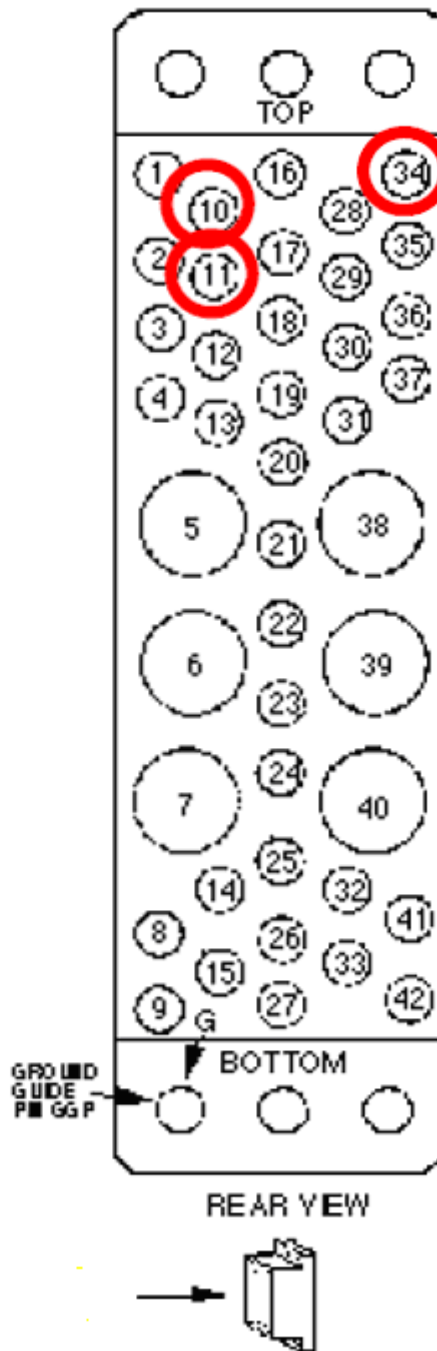

Fig. 2: Backplane NIM connector



## Front and back panel

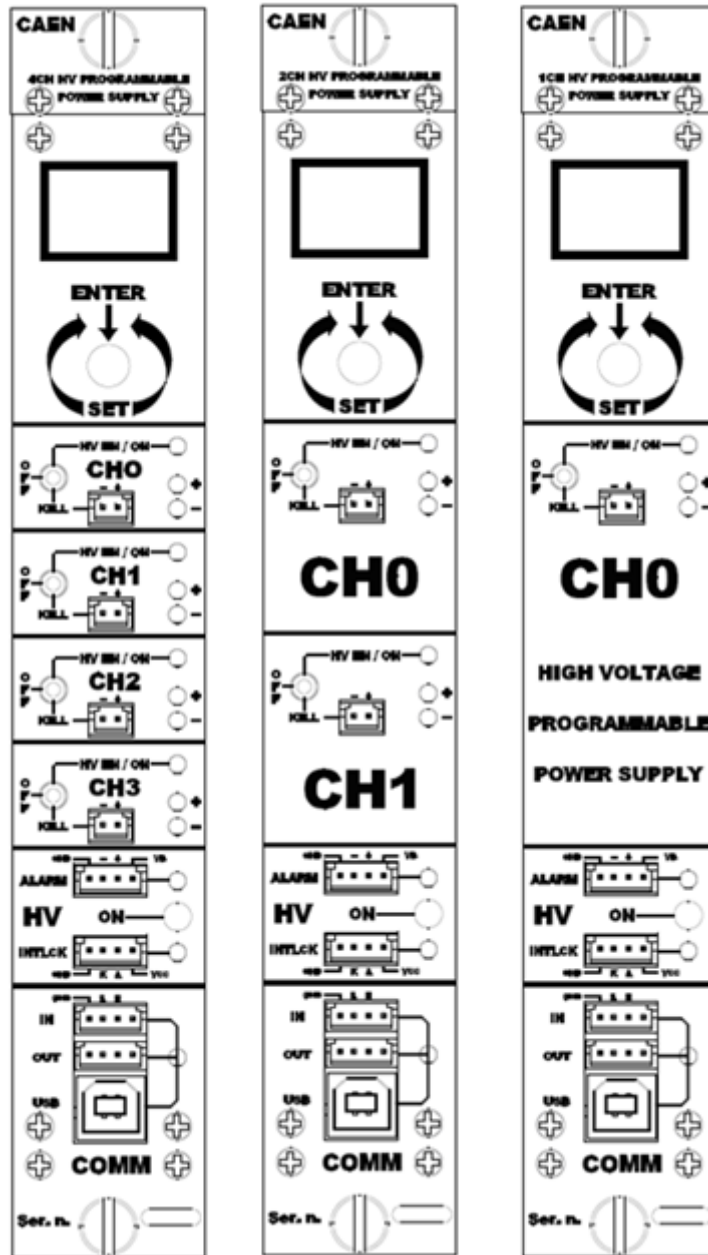

Fig. 3: Mod. N1419 series front panel (std., A, B)

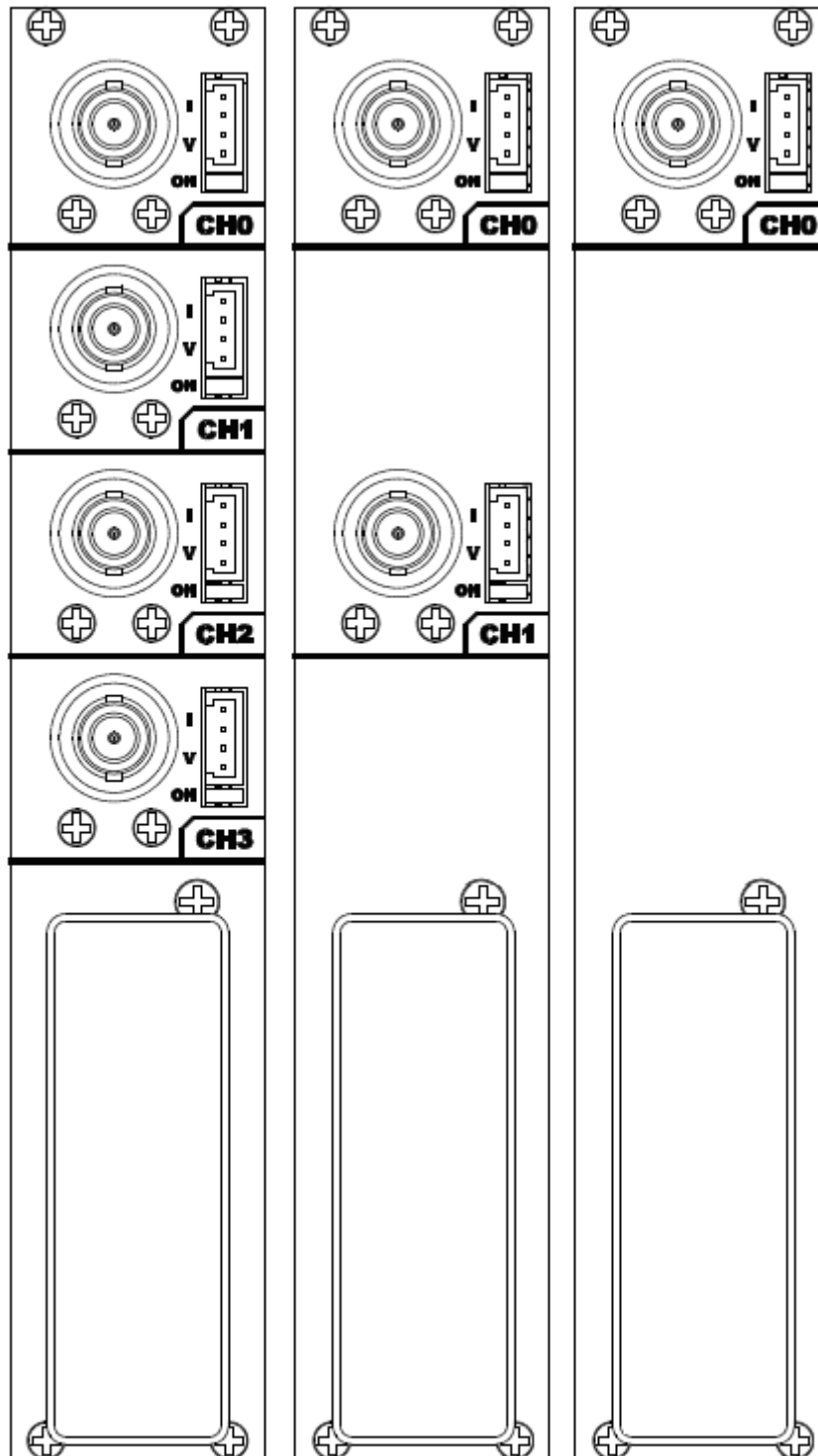

Fig. 4: Mod. N1419 series back panel (std., A, B)

## Front panel connections

### Local control section

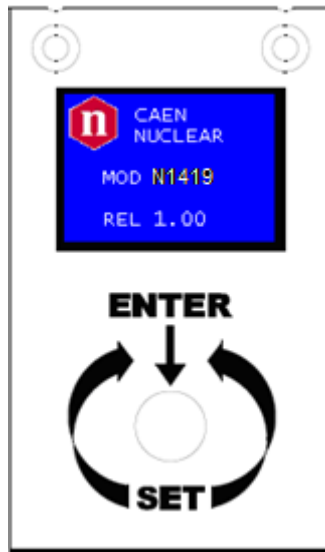

Fig. 5: Local control panel

NAME:	TYPE:	FUNCTION:
MONITOR	1" OLED DISPLAY (96x64)	Local settings monitoring
TUNE	ROTARY SWITCH	Parameter and Mode setting

### Channel control section

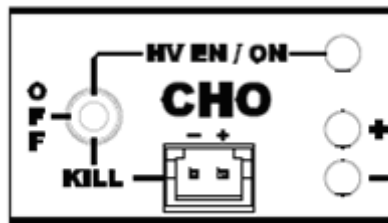
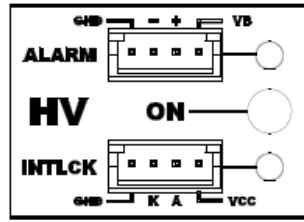

Fig. 6: Channel control panel and Kill scheme

NAME:	TYPE:	FUNCTION:
HV_EN/OFF/KILL	3 POS. SWITCH	Channel Enable and turning OFF/KILL
ON	RED LED	HV On enabled
REMOTE KILL	AMP 280370-2	The channel is KILLED either as the +/- contacts are open or as a +4÷6Vdc voltage is fed to pin -
+	GREEN LED	Positive polarity
-	YELLOW LED	Negative polarity

HV Status control section



**Fig. 7: N1419 HV Status control panel**

NAME:	TYPE:	SIGNAL:	FUNCTION:
ON	RED LED		<i>HV On enabled (at least one channel ON)</i>
ALARM	RED LED/ AMP 280371-2.	Out	<i>Alarm status signalled (active LOW)</i>
INTERLOCK	RED LED/ AMP 280371-2	In	<i>Interlock signal</i>

Alarm signal

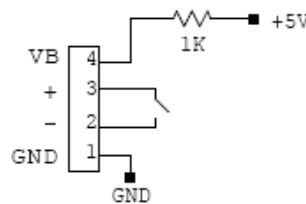

**Fig. 8: N1419 ALARM electrical scheme**

As an Alarm condition is detected (see p. 32 and 34) pins 2 and 3 (- and +) are closed; the contact can be used to switch an external device supplied by an external source, otherwise the VB and GND references can be used to provide a TTL compatible level on pin 2 and 3.

In the first case (externally supplied device) the maximum allowed ratings are:

- Maximum voltage between + and -: 12V
- Maximum sink current across + and -: 100mA

In the latter case, in order to produce a TTL compatible Alarm Out, pin 3 (+) must be connected with pin 4 (VB) and pin 1 (GND) with pin 2 (-); see the diagram below:

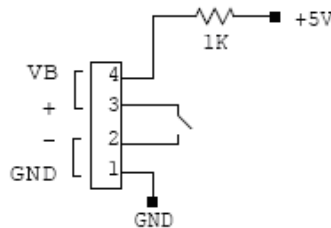

**Fig. 9: N1419 ALARM TTL configured**

Interlock signal

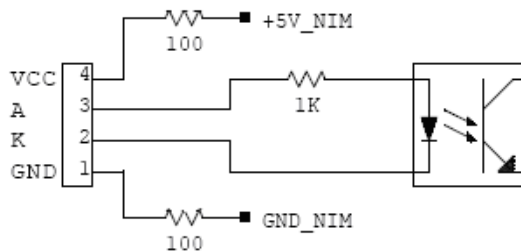

**Fig. 10: N1419 INTERLOCK electrical scheme**

A schematic diagram of the Interlock input is shown in the figure above, where the diode is part of optocoupler stage.

Interlock means that channels are hardware disabled. The interlock operation is explained by the following table:

Table 3: Interlock operation

CONFIGURATION ↓	INTERLOCK MODE (p.16) →	OPEN	CLOSE
leave contact open		INTERLOCK	ENABLED
voltage level (0÷1V, ~5mA current) between pin 2 and pin 3		INTERLOCK	ENABLED
short circuit pin 1 with pin 2, and pin 3 with pin 4		ENABLED	INTERLOCK
voltage level (4÷6V, ~5mA current) between pin 2 and pin 3		ENABLED	INTERLOCK

The front panel Interlock LED is ON when the INTERLOCK is enabled; as INTERLOCK is enabled, channels are turned off at the fastest available rate, regardless the RAMP DOWN setting.

### Remote communication control section

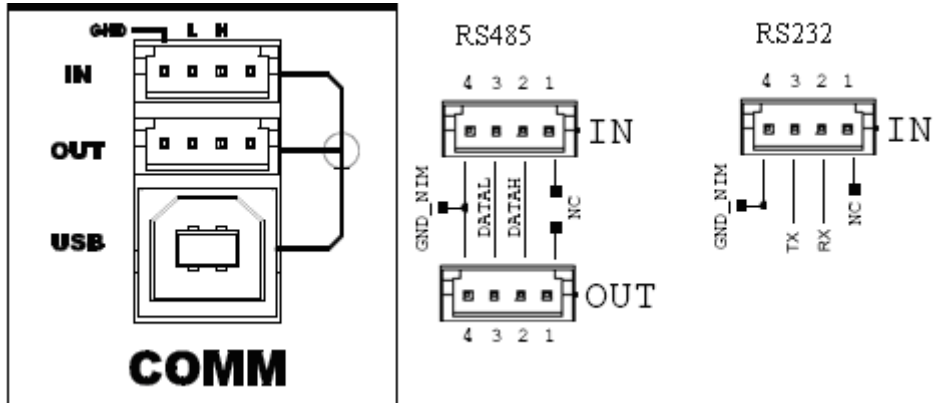

Fig. 11: Remote communication control and RS485 I/O – RS232 IN electrical scheme

NAME:	TYPE:	FUNCTION:
IN	AMP 280371-2	RS485 Input <sup>1</sup> ; adaptable to RS232 standard
OUT	AMP 280371-2	RS485 Output
USB	B TYPE USB	USB2.0 compliant realized via USB ↔ RS232 FT232BM converter

<sup>1</sup> RS 485 Serial Port Interface allows to control up to 32 modules connected by a twisted pair cable; the first and last modules must be terminated, see p.36.

## Rear panel connections

### HV Channel Output

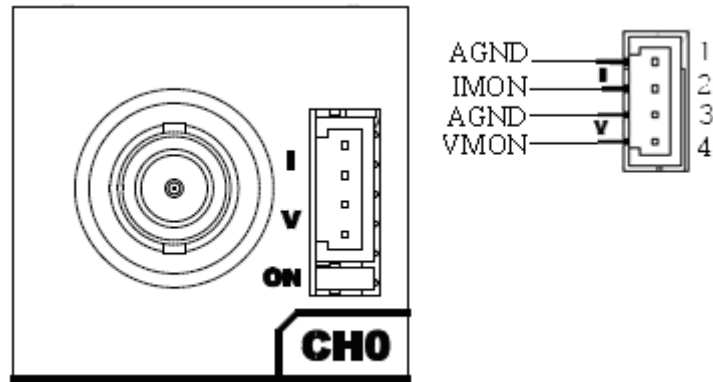

Fig. 12: HV Channel panel and test point electrical scheme

NAME:	TYPE:	FUNCTION:
MON	AMP 280371-2	Vout/Iout Test point
OUT	SHV	HV Channel Output

The test points allow to monitor the Channel Output Voltage and Current according to the following conversion:

<b>VMON:</b>	Voltage level (1V = 136 V $\pm$ 1% readout; same polarity as channel)
<b>IMON high range:</b>	Voltage level (1V = 44 $\mu$ A $\pm$ 3% readout; positive, 0÷5 V range)
<b>IMON low range:</b>	Voltage level (1V = 4.4 $\mu$ A $\pm$ 3% readout; positive, 0÷5 V range)

## Imon Zoom

Imon Zoom is an optional feature that allows to monitor the channel current with an increased resolution (10x) in the 0 – 20  $\mu$ A range; if the Imon Zoom is installed, by selecting Imon Range = LOW (see p.17), the output current is monitored with 0.5nA resolution (instead of 5 nA), in the 0 – 20  $\mu$ A range. It is important to notice that, if Imon Range = LOW is selected, and the channel draws a current larger than 20  $\mu$ A, then Overcurrent is signalled.

## Technical specifications table

**Table 4: Mod. N1419 Channel technical specifications**

Output channels:	Positive or Negative Polarity (requires internal setting, see p.35)		
Output ranges:	500 V / 200 $\mu$ A		
Max. Ch. Output Power:	100 mW		
Vset / Vmon Resolution:	10 mV		
Iset / Imon Resolution <sup>2</sup> :	If IMON RANGE = High is selected resolution is 5 nA If IMON RANGE = Low is selected resolution is 0.5 nA		
Vmax:	0 $\div$ 510 V Absolute maximum HV level that the channel is allowed to reach, independently from the preset value Vset. Output voltage cannot exceed the preset value Vmax. The accuracy is 1 % $\pm$ 0.5 V		
Vmax resolution:	$\pm$ 0.1 V		
Alarm output:	Open collector, 100 mA maximum sink current		
Interlock input:	LOW: <1V; current $\sim$ 5mA; HIGH: 4 $\div$ 6 V		
Ramp Up/Down:	1 $\div$ 50 Volt/s, 1 Volt/s step		
Trip:	Max. time an "overcurrent" is allowed to last (seconds). A channel in "overcurrent" works as a current generator; output voltage varies in order to keep the output current lower than the programmed value. "Overcurrent" lasting more than set value (1 to 9999) causes the channel to "trip". Output voltage will drop to zero either at the Ramp-down rate or at the fastest available rate, depending on Power Down setting; in both cases the channel is put in the OFF state. If trip= INFINITE, "overcurrent" lasts indefinitely. TRIP range: 0 $\div$ 999.9 s; 1000 s = Infinite. Step = 0.1 s		
Vmon vs. Vout Accuracy: <sup>3</sup>	$\pm$ 0.02% of read value $\pm$ 0.2V		
Vset vs. Vmon Accuracy: <sup>4</sup>	$\pm$ 0.02% of read value $\pm$ 0.2V		
Imon vs. Iout Accuracy: <sup>4</sup>	If IMON RANGE = High : $\pm$ 2% of read value $\pm$ 20nA If IMON RANGE = Low: $\pm$ 2% of read value $\pm$ 2nA		
Iset vs. Imon Accuracy: <sup>4</sup>	If IMON RANGE = High : $\pm$ 2% of read value $\pm$ 30nA If IMON RANGE = Low: $\pm$ 2% of read value $\pm$ 3nA		
Voltage Ripple: <sup>4</sup>	<b>band width</b>	<b>typical</b>	<b>maximum</b>
	10Hz $\div$ 100Hz	<5mVpp	<5mVpp
	100Hz $\div$ 100MHz	<5mVpp	<5mVpp
Humidity range:	0 $\div$ 80%		
Operating temperature:	0 $\div$ 45°C		
Storage temperature:	-10 $\div$ 70°C		
Vout / Temperature coefficient:	max. 50ppm / °C		
Vout /voltage coefficient:	max 2ppm/mV		
Imon / Temperature coefficient:	max 100ppm/C°; max 300ppm/C° with Imon X10 zoom (optional)		
Long term stability Vout vs. Vset:	$\pm$ 0.02% (after one week @ constant temperature)		

<sup>2</sup> The module is calibrated by introducing a positive offset on the current monitor, see details p. 24

<sup>3</sup> From 10% to 90% of Full Scale Range

<sup>4</sup> Measured with: 1m cable length; 2nF capacitance

### 3. Operating modes





 **CAUTION: N1419 MUST BE USED ONLY IN CRATES WITH FORCED COOLING AIR FLOW!**

Module control can take place either locally, or remotely, via USB or RS485 (see p. 25).

### Programmable parameters

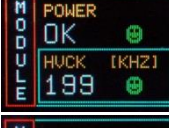
#### Boards parameters









General board parameters (CONTROL can be operated both in LOCAL and REMOTE mode; other monitor and settings are allowed in LOCAL mode only; see p.18) include:

Parameter:	Function:	Display:
Power (Monitor)	Module power supply status	
Termination (Monitor)	Local Bus termination status (ON/OFF)	
HV Clock (Monitor)	Sync clock frequency (200±10 kHz correct value)	
Local Bus Baud Rate (Monitor/Set)	9600, 19200, 38400, 57600, 115200 Baud	
Local Bus Address (Monitor/Set)	Local Bus address for remote communication (0÷31)	
USB Baud Rate (Monitor/Set)	9600, 19200, 38400, 57600, 115200 Baud	
INTERLOCK (Monitor/Set)	CLOSED / OPEN OPERATION (see p.12)	
CONTROL (Monitor/Set)	REMOTE: the module is controlled remotely; local monitor is allowed; LOCAL/REMOTE switch is enabled  LOCAL: the module is controlled locally; remote monitor is allowed	

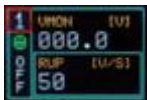

## Channel settings

For each channel the following parameters can be programmed and monitored either locally or remotely (see p.25):

Parameter:	Function:	Unit:	Display:
Vmon	High Voltage Monitored value	Volt	
Imon	Current Monitored value	μA	
Vset	High Voltage programmed value	Volt	
Iset	Current Limit programmed value	μA	
MaxV	Absolute maximum High Voltage level that the channel is allowed to reach (see p. 15)	V	
Ramp-Up	Maximum High Voltage increase rate	V/s	
Ramp-Down	Maximum High Voltage decrease rate	V/s	
Power Down	Power Down mode after channel TRIP	KILL or RAMP	
Trip	Maximum time an "overcurrent" is allowed to last expressed in seconds (see p.15)	s	
Imon Range	Current Monitor Zoom 10x (optional)	H or L	

## Local Control

Insert the unit inside a powered NIM crate, and switch it ON. At the power the Display shows for a few seconds the following screen.

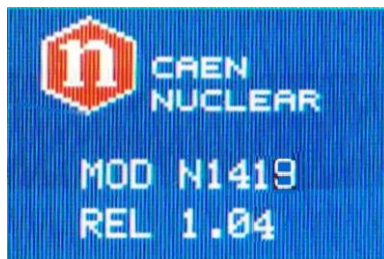
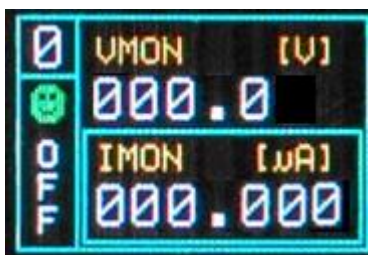

**Fig. 13: Welcome screen**

At this point the module is ready to be operated locally. The TUNE ROTARY SWITCH (see p.11) is lit up as long as Local Control is enabled.

## HV connection

Verify the channels polarity (polarity setting is explained at p.35) checking that the polarity LEDs are switched on according to the programmed configuration (see p.11); verify the HV\_EN/OFF/KILL 3 POS. SWITCH of each channel is set to OFF; the Display will show the following message in the left lower row:



**Fig. 14: Channel OFF status screen**

now connect the HV cable linking the outputs to the loads to be supplied and enable the HV outputs switching the HV\_EN/OFF/KILL 3 POS. SWITCH in the HV\_EN position; the Display will show the following message in the left lower row:

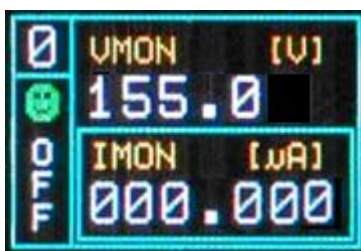

**Fig. 15: Channel ON status screen**

The KILL position of the HV\_EN/OFF/KILL 3 POS. SWITCH allows to turn off the module at the fastest available rate; the Display will show the following message in the left lower row:

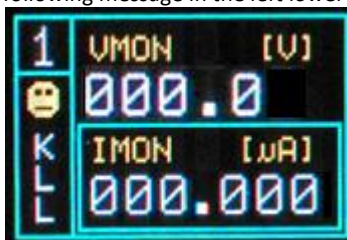

**Fig. 16: Channel KILL status screen**

## Module settings

Module settings are general board settings; turn the TUNE ROTARY SWITCH until this screen is shown:



**Fig. 17: Mode settings status screen**

Push the TUNE ROTARY SWITCH in order to access MODULE parameters; the MODULE frame becomes red:



**Fig. 18: Mode settings access screen**

The TUNE ROTARY SWITCH allows to select the parameter to be set; turn the ROTARY SWITCH until such parameter is displayed (for example CONTROL), then select it by pushing the ROTARY SWITCH (the parameter is shown with a red frame as long as it is active):



**Fig. 19: Mode settings edit screen**

Select the desired value by turning the TUNE ROTARY SWITCH and confirm it by pushing the switch itself.

## Channel settings

In order to operate Output Channel settings:

Turn the TUNE ROTARY SWITCH until the channel number to be set is displayed in the left upper row (for example Channel 0)

Push the TUNE ROTARY SWITCH: at this point the frame of the left upper row (channel number) becomes red and the channel is selected



**Fig. 20: Channel settings edit screen**

Turn the TUNE ROTARY SWITCH until the parameter to be set (for example VSET) is displayed in the right lower row



**Fig. 21: Channel VSET select screen**

Push the TUNE ROTARY SWITCH: at this point the parameter is selected, its frame is shown in red and its name in blue; it is now possible to change the parameters value



**Fig. 22: Channel VSET access screen**

Turn the TUNE ROTARY SWITCH until the value digit to be edited is shown in yellow, the parameter name in yellow



**Fig. 23: Channel VSET digit selection screen**

Push the TUNE ROTARY SWITCH: at this point the value digit becomes yellow and can be edited



Fig. 24: Channel VSET digit access screen

Turn the TUNE ROTARY SWITCH until the digit reaches the desired value



Fig. 25: Channel VSET digit adjust screen

Confirm it by pushing the TUNE ROTARY SWITCH, the edited digit returns blue



Fig. 26: Channel VSET digit confirm screen

Once all the digits are set to the desired value, turn the TUNE ROTARY SWITCH until the parameter name returns blue



Fig. 27: Channel VSET confirm screen

Push the TUNE ROTARY SWITCH in order to de-select the parameter, the frame returns to blue

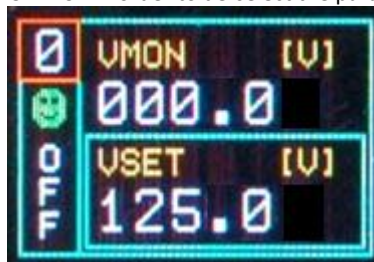

Fig. 28: Channel VSET de-select screen

It is now possible to set another parameter; note that the POWER DOWN and IMRANGE setting has not digits to be edited, but two options, TRIP/KILL and HIGH/LOW respectively:



**Fig. 29: Channel KILL screen**

In order to access another channel, the EXIT parameter has to be selected



**Fig. 30: Channel EXIT screen**

Now by turning the TUNE ROTARY SWITCH another channel number to be set can be selected.

If CONTROL MODE (see p.25) is set to REMOTE, the left lower row reports DIS (Disabled), since the channel can be accessed only via the serial links (see p.25). If the INTERLOCK MODE is changed while one channel is ON, the channel is turned OFF and the left lower row reports ILK (Interlock); if the channel is OFF, it cannot be turned ON, until it is enabled according to the Interlock logic (see p.12).

### Group Settings<sup>5</sup>

Group settings allow to broadcast the same parameter value to all channels.

In order to operate Group settings:

Turn the TUNE ROTARY SWITCH until ALL is displayed in the left column

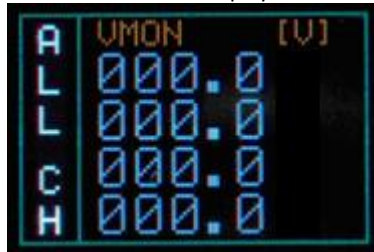

**Fig. 31: Group selection**

Push the TUNE ROTARY SWITCH: at this point the frame of the left column becomes red and the GROUP is selected. Turn the TUNE ROTARY SWITCH until the parameter to be set (for example VSET) is displayed in the right column (all four channels values).

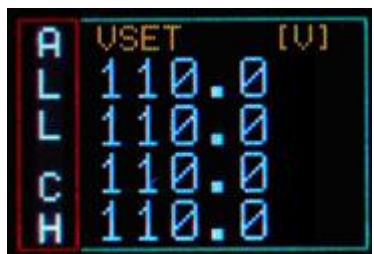

**Fig. 32: Group active**

<sup>5</sup> Mod. N1419B has not group settings; Mod. N1419A has group settings, 2 channels values are displayed

Push the TUNE ROTARY SWITCH: at this point the parameter is selected, its frame is shown in red and its name in blue (only one value common to all channels; pre-set value is picked from Channel 0); it is now possible to change the parameters value.



Fig. 33: Group VSET access screen

Turn the TUNE ROTARY SWITCH until the value digit to be edited is shown in blue, the parameter name in yellow



Fig. 34: Group VSET digit selection screen

Push the TUNE ROTARY SWITCH: at this point the value digit becomes yellow and can be edited



Fig. 35: Group Channel VSET digit access screen

Turn the TUNE ROTARY SWITCH until the digit reaches the desired value



Fig. 36: Group VSET digit adjust screen

Confirm it by pushing the TUNE ROTARY SWITCH, the edited digit returns blue



Fig. 37: Group VSET digit confirm screen

Once all the digits are set to the desired value, turn the TUNE ROTARY SWITCH until the parameter name returns blue. Push the TUNE ROTARY SWITCH in order to de-select the parameter, the frame returns to blue; when the parameter is not active, the parameter status of the four channels is shown.

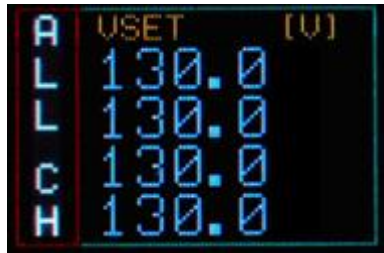

**Fig. 38: Channel VSET de-select screen**

In order to go to individual channel settings, the EXIT parameter has to be selected





**Fig. 39: Group EXIT screen**

### Smileys

Three types of Smileys in the display indicate:

**Table 5: Smileys list**

Smiley	Meaning
	OK Status
	WARNING Status
	ALARM Status

## Current monitor offset calibration

The module is calibrated by introducing a positive offset on the current monitor. This type of calibration allows to monitor very low current thus removing possible issues due to components and working temperatures related negative offsets. The absolute value of delivered current can be quantified by following the steps below:

- 1) Turn on the module, after a warm-up of about 30 minutes with operating voltage and load disconnected (no link between N1419 and detectors) then read the monitored current value  $I_{mon} = I_1$  (offset)
- 2) Turn off the channel and connect the load
- 3) Turn on the channel with the same voltage set as point 1)
- 4) Wait a few minutes and read again the current value monitor  $I_{mon} = I_2$  (offset +  $I_{out}$ )
- 5) The value of current output is equal to the difference between  $I_2$  and  $I_1$  ( $I_{out} = I_2 - I_1$ )

Leakage currents equal to 1 nA / 100 V shall be tolerated; e.g.  $V_{out} = 400V$ ,  $I_{mon} = +6$  nA (2nA Offset + 4nA current leakage/400V). The offset introduced is equal to 20nA for high range and 2nA for low range with output voltage at 10% of full scale and 20 °C temperature.



## Remote Control

Module control can take place remotely, via USB or RS485; the latter allows to build a N1419s' daisy chain network. The CAEN NIM8301 7U 12 Slot Smart Fan Unit 300/600 W Crate allows also to communicate with the module via Ethernet.

### Serial Links

#### USB communication

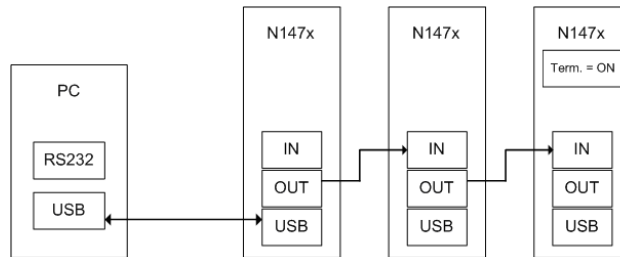

**Fig. 40: USB communication diagram**

The module is provided with a USB2.0 compliant interface (see p.11). The N1419 can be programmed via PC by connecting the PC USB port with the N1419 USB B-type port; the featured controller, the FT232BM chip requires drivers freely available at [www.ftdichip.com](http://www.ftdichip.com) (Drivers section); the site also provides installation instructions for all OS's (Documents section)

The connection can be performed via terminal emulator, such as HyperTerminal, configured as follows:

- baud rate 9600 (the same set on the N1419! See p.19)
- Data bits: 8
- Parity: none
- stop bit: 1
- Flow control: Xon Xoff

It is also possible to build a daisy chain of up to 32 N1419's, with the first module connected to the PC USB port and the subsequent ones daisy chained through the COMM IN/OUT, as explained on p.31 ; in this case communication with the chained modules is achieved through the USB - RS485 Communication Protocol, see p.31. All modules must be assigned a LOCAL BUS ADDRESS (see p.16) different from one another and the last one must be terminated (see p.37).

#### RS232 communication

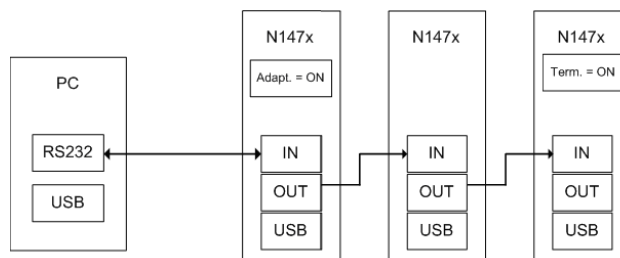

**Fig. 41: RS232 communication diagram**

In order to control the module via RS232 it is necessary to use the module's COMM IN port (refer to p.13 for RS232 signals) and to follow adaptation instructions (see p.37).

The connection can be performed via terminal emulator, such as HyperTerminal, configured as follows:

- baud rate 9600 (the same set on the N1419! See p.16)
- Data bits: 8
- Parity: none
- stop bit: 1
- Flow control: Xon Xoff

It is also possible to build a daisy chain of up to 32 N1419's, with the first module connected to the PC RS232 port and the subsequent ones daisy chained through the COMM IN/OUT, as explained on p.13; in this case communication with the chained modules is achieved through the USB - RS485 Communication Protocol . All modules must be assigned a LOCAL BUS ADDRESS (see p.16) different from one another and the last one must be terminated (see p.37).

**RS485 communication**

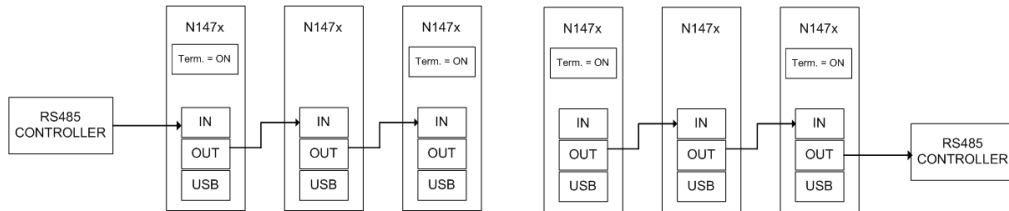

**Fig. 42: RS485 communication diagram**

The COMM IN / OUT connectors implement a RS485 type LOCAL BUS which allows to build a 32 modules daisy chain. This can be achieved through the following steps:

- Connect the connector OUT of a module to corresponding the IN connector of the next one
- Assign to each module a different address (LOCAL BUS ADDR); see p. 16
- Ensure that the LOCAL BUS BIT RATE is the same for all modules; see p. 16
- Terminate the first and the last module in the chain (see p.37)

The module control can be done in one of the following ways:

- o by connecting a RS485 controller to the first module's COMM IN port
- o by connecting a RS485 controller to the last module's COMM OUT port

Communication with the chained modules is achieved only through the USB - RS485 Communication Protocol, see p.25.

**Ethernet communication**

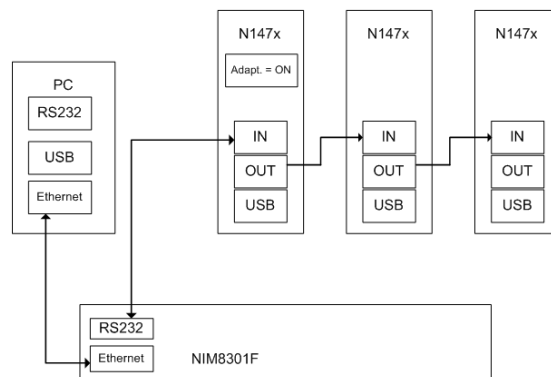

**Fig. 43: Ethernet communication diagram**

It is possible to communicate via Ethernet with one or more daisy chained N1419 modules through the NIM8301 Fan Unit<sup>6</sup>. Communication via Ethernet is possible only through the USB - RS485 Communication Protocol. The single module or the first module of the daisy chain must be connected to the Fan Unit RS232 port through the cable adapter (see figure below) connected to the N1419 COMM IN port; SW[200, 201] switch placed on the Microcontroller board inside the module must be set to Adaptation ON (see p.35).

<sup>6</sup> The CAEN Mod. NIM8301 is a 7U (5+2) full size NIM crate (19"-12 slot) available with pluggable 300W and 600W power supplies, ventilated by pluggable 2U fan unit. Remote control and monitoring take place through CAN bus, Ethernet, USB and RS232 interfaces.

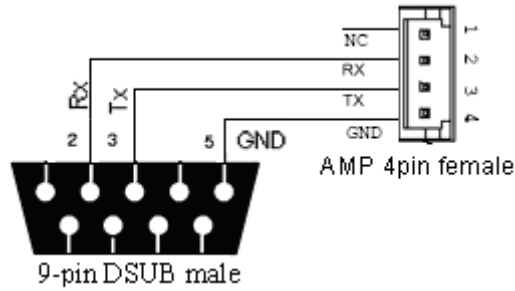

Fig. 44: RS232 port cable adapter

## Communication Control

In order to launch the communication, type *CAEN* and then <Enter>  
 As the communication is established, the Main Menu will be displayed.

### Remote Control: Main Menu

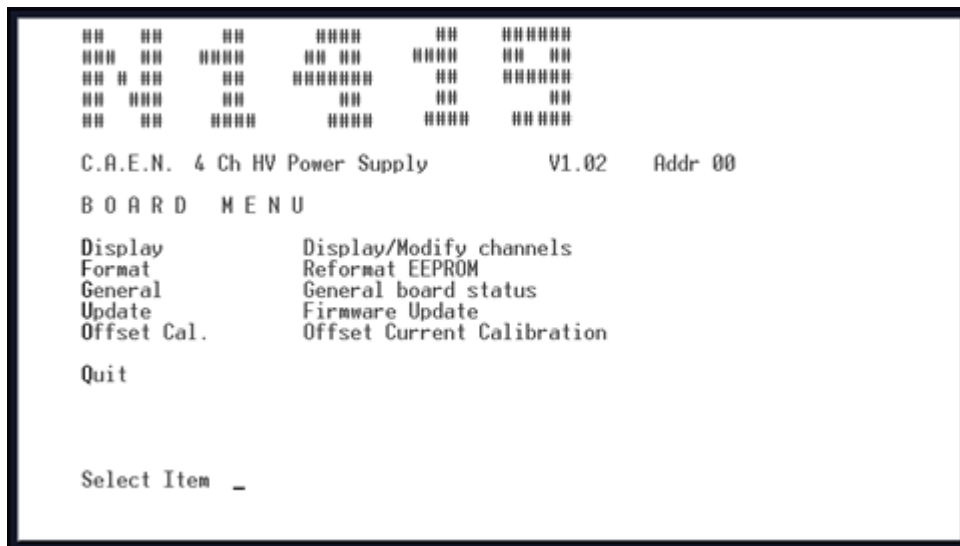
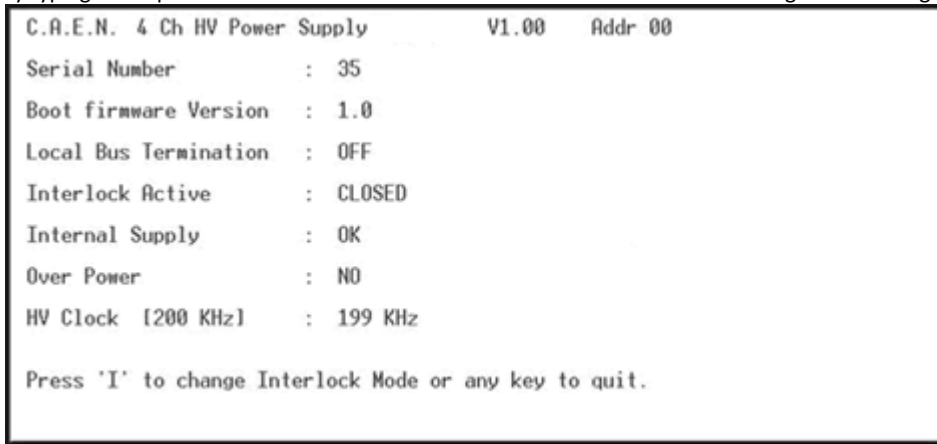

Fig. 45: Main Menu

- Type **D** to set/monitor channels parameters
- Type **F** to format the EEPROM
- Type **G** to monitor board status
- Type **U** to upgrade the firmware
- Type **O** to perform the current offset calibration
- Type **Q** to exit the program

**Remote Control: General Menu**

By typing **G** it is possible to access the General Menu which includes the board's general settings.



**Fig. 46: Board Status Menu**

**Remote Control: Channels Menu**

By typing **D** it is possible to monitor and set all the channels parameters listed at p.16

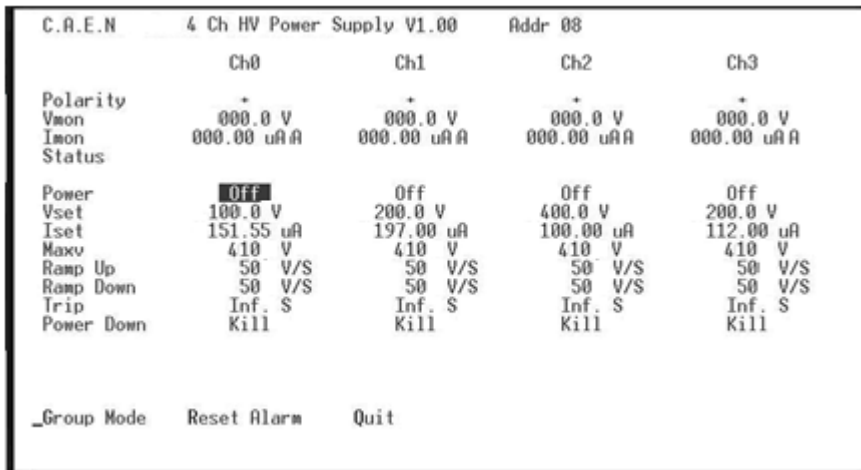

**Fig. 47: Channels Menu**

In order to change one parameter: point the parameter with the arrow keys (see figure below), and type the desired value, confirm by pressing <Enter>; Power and Power Down can be changed using the <Space> bar.

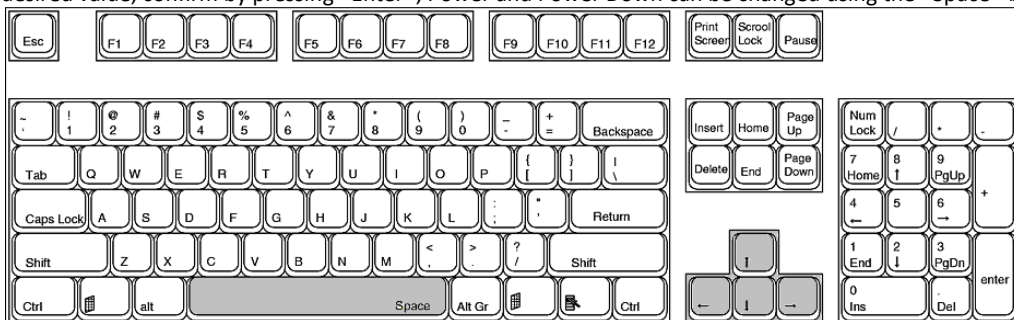

**Fig. 48: PC keyboard**

When one parameter is active, by typing **G** it is possible to make a “group setting”, i.e. broadcast the same value to all channels (the parameter becomes active on all channels, see figure).

C.A.E.N.	4 Ch HV Power Supply V1.00 Addr 00			
	Ch0	Ch1	Ch2	Ch3
Polarity	+	+	+	-
Vwon	000.0 V	000.0 V	000.0 V	000.0 V
Iwon	000.00 uA	000.00 uA	000.00 uA	000.00 uA
Status	Dis	Dis	Dis	Dis
Power	Off	Off	Off	Off
Vset	100.0 V	100.0 V	100.0 V	100.0 V
Iset	200.00 uA	200.00 uA	200.00 uA	200.00 uA
Maxv	500 V	500 V	500 V	500 V
Ramp Up	50 V/S	50 V/S	50 V/S	50 V/S
Ramp Down	50 V/S	50 V/S	50 V/S	50 V/S
Trip	Inf. S	Inf. S	Inf. S	Inf. S
Power Down	Kill	Kill	Kill	Kill
Iwon Range	High	High	High	High
Group Mode    Reset Alarm    Quit				

Fig. 49: Channels group setting

Type **Q** to exit the Menu.

### Remote Control: firmware upgrade

By typing **U** it is possible to access the firmware upgrade menu:

C.A.E.N.	4 Ch HV Power Supply V1.00 Addr 00			
Firmware Update. Are you sure ? [y/n] _				

Fig. 50: Firmware Upgrade Menu/1

If **<y>** is typed, then the following menu is shown:

C.A.E.N.	4 Ch HV Power Supply V1.00 Addr 00			
Firmware Update. Are you sure ? [y/n]				
When the message 'Firmware Updating Complete' is displayed, wait few seconds and then press 'caen'.				
Resetting ..				
Flash Erasing ...				
Ready to receive				
Please send the new firmware				

Fig. 51: Firmware Upgrade Menu/2

At this point it is necessary to upload the updated firmware.

If "HyperTerminal" is used it is necessary to perform "Transfer" and "Send Text File" operations by selecting the file "N1419.xxx"

**Remote Control: format EEPROM**

By typing **F** it is possible to access the format EEPROM menu:

```
C.A.E.N.      4 Ch HV Power Supply  V1.00

Format EEPROM. Are you sure ? [y/n]
```

**Fig. 52: Format EEPROM Menu**

After the **FORMAT** command, all the channels have the following settings:

- Vset = 0 V
- Iset = 21.0  $\mu$ A
- Ramp Up / Down = 5 V/s
- Trip = 10 s
- MaxV = 510 V
- Power Down = Kill

Module setting:  
Interlock Mode = Active CLOSED

**Remote Control: Current offset calibration**

By typing **O** it is possible to perform the current offset calibration (the calibration must be performed after 30minutes operation at least); it is necessary to perform a calibration anytime external operating conditions change; the following instructions are displayed:

```
C.A.E.N.      4 Ch HV Power Supply  V1.02  Addr 00

*** NO LOAD CURRENT CALIBRATION ***

!!! WARNING !!!

For this calibration all channels MUST be OFF
and disconnected from any load.

Are you sure ? [y/n] _
```

**Fig. 53: Current offset calibration warning**

Once channels are off and disconnected from the load, type **y**; at this point the program asks for the current value (**VSET**) selected for the offset compensation, such value is common to all channels; factory calibration is performed at 250V, type **VSET** then press <ENTER>

```
C.A.E.N.      4 Ch HV Power Supply  V1.03  Addr 00

*** NO LOAD IMON CALIBRATION ***

Enter VSET : _
```

**Fig. 54: Current offset calibration VSET selection**

the calibration is performed and the program asks for coefficients to be saved.

```
C.A.E.N.      4 Ch HV Power Supply  V1.02  Addr 00
*** NO LOAD CURRENT CALIBRATION ***
Wait for channel Off ...
Step 1 ... [00 s]
Step 2 ... [00 s]
Press '0' to exit or any key to save coefficients._
```

Fig. 55: Current offset calibration confirmation

## USB - RS485 Communication Protocol

The following Protocol allows to communicate with up to 32 daisy chained modules. The Protocol is based on commands made of ASCII characters strings. The protocol requires firmware revision 1.0.1 or greater.

### Command Format

The Format of a command string is the following :

**\$BD:\*\*,CMD:\*\*\*,CH\*,PAR:\*\*\*,VAL:\*\*\*.\*\*<CR, LF >**

The fields that form the command are :

**BD : 0..31** module address (to send the command)

**CMD : MON, SET**

**CH : 0..4** (4 for the commands related to all Channels)

**PAR :** (see parameters tables)

**VAL :** (numerical value must have a Format compatible with resolution and range)

### Format of response string

#### Format response in case of error

String	Function (Units)
#BD:**,CMD:ERR	Wrong command Format or command not recognized
#BD:**,CH:ERR	Channel Field not present or wrong Channel value
#BD:**,PAR:ERR	Field parameter not present or parameter not recognized
#BD:**,VAL:ERR	Wrong set value (<Min or >Max)
#BD:**,LOC:ERR	Command SET with module in LOCAL mode

Each string is terminated by < CR, LF >

#### Format response in case of correct command

String	Function (Units)
#BD:**,CMD:OK	command Ok
#BD:**,CMD:OK,VAL:***	command Ok *** = value for command to individual Channel
#BD:**,CMD:OK,VAL:*,*,**	command Ok *,*,** = values Ch0,1,2,3 for command to all Channels

Numerical value Field '**VAL**' has Format compatible (comma and decimal part) with the resolution and the range related to the parameter.

Each string is terminated by < CR, LF >

## MONITOR commands related to the Channels

The following table contains the strings to be used to handle monitor commands related to the Channels.

The 'X' in the Field 'Channel' can be set in the '0..4' range.  
 When 'X=4' the module returns the values of the parameter of all 4 Channels.

String	Function (Units)
\$BD:xx,CMD:MON,CH:X,PAR:VSET	Read out VSET value ( XXXX.X V )
\$BD:xx,CMD:MON,CH:X,PAR:VMIN	Read out VSET minimum value ( 0 V )
\$BD:xx,CMD:MON,CH:X,PAR:VMAX	Read out VSET maximum value ( 500.0 V )
\$BD:xx,CMD:MON,CH:X,PAR:VDEC	Read out VSET number of decimal digits
\$BD:xx,CMD:MON,CH:X,PAR:VMON	Read out VMON value ( XXXX.X V )
\$BD:xx,CMD:MON,CH:X,PAR:ISET	Read out ISET value ( XXXX.XX $\mu$ A )
\$BD:xx,CMD:MON,CH:X,PAR:IMIN	Read out ISET minimum value ( 0 $\mu$ A )
\$BD:xx,CMD:MON,CH:X,PAR:IMAX	Read out ISET maximum value ( 200.00 $\mu$ A )
\$BD:xx,CMD:MON,CH:X,PAR:ISDEC	Read out ISET number of decimal digits
\$BD:xx,CMD:MON,CH:X,PAR:IMON	Read out IMON value ( XXXX.XX $\mu$ A )
\$BD:xx,CMD:MON,CH:X,PAR:IMRANGE	Read out IMON RANGE value ( HIGH / LOW )
\$BD:xx,CMD:MON,CH:X,PAR:IMDEC	Read out IMON number of decimal digits ( 2 HR, 3 LR )
\$BD:xx,CMD:MON,CH:X,PAR:MAXV	Read out MAXVSET value ( XXXX V )
\$BD:xx,CMD:MON,CH:X,PAR:MVMIN	Read out MAXVSET minimum value ( 0 V )
\$BD:xx,CMD:MON,CH:X,PAR:MVMAX	Read out MAXVSET maximum value ( 510 V )
\$BD:xx,CMD:MON,CH:X,PAR:MVDEC	Read out MAXVSET number of decimal digits
\$BD:xx,CMD:MON,CH:X,PAR:RUP	Read out RAMP UP value ( XXX V/S )
\$BD:xx,CMD:MON,CH:X,PAR:RUPMIN	Read out RAMP UP minimum value ( 1 V/S )
\$BD:xx,CMD:MON,CH:X,PAR:RUPMAX	Read out RAMP UP maximum value ( 50 V/S )
\$BD:xx,CMD:MON,CH:X,PAR:RUPDEC	Read out RAMP UP number of decimal digits
\$BD:xx,CMD:MON,CH:X,PAR:RDW	Read out RAMP DOWN value ( XXX V/S )
\$BD:xx,CMD:MON,CH:X,PAR:RDWMIN	Read out RAMP DOWN minimum value ( 1 V/S )
\$BD:xx,CMD:MON,CH:X,PAR:RDWMAX	Read out RAMP DOWN maximum value ( 50 V/S )
\$BD:xx,CMD:MON,CH:X,PAR:RDWDEC	Read out RAMP DOWN number of decimal digits
\$BD:xx,CMD:MON,CH:X,PAR:TRIP	Read out TRIP time value ( XXXX.X S )
\$BD:xx,CMD:MON,CH:X,PAR:TRIPMIN	Read out TRIP time minimum value ( 0 S )
\$BD:xx,CMD:MON,CH:X,PAR:TRIPMAX	Read out TRIP time maximum value ( 1000.0 S )
\$BD:xx,CMD:MON,CH:X,PAR:TRIPDEC	Read out TRIP time number of decimal digits
\$BD:xx,CMD:MON,CH:X,PAR:PDWN	Read out POWER DOWN value ( RAMP / KILL )
\$BD:xx,CMD:MON,CH:X,PAR:POL	Read out POLARITY value ( '+' / '-' )
\$BD:xx,CMD:MON,CH:X,PAR:STAT	Read out Channel status value ( XXXXX )

Meaning of STATUS bits (value read in decimal Format)

Bit	Function
Bit 0 → ON	1 : ON 0 : OFF
Bit 1 → RUP	1 : Channel Ramp UP



Bit 2 → RDW	1 : Channel Ramp DOWN
Bit 3 → OVC	1 : IMON >= ISET
Bit 4 → OVV	1 : VMON > VSET + 2.5 V
Bit 5 → UNV	1 : VMON < VSET – 2.5 V
Bit 6 → MAXV	1 : VOUT in MAXV protection
Bit 7 → TRIP	1 : Ch OFF via TRIP (I <sub>mon</sub> >= I <sub>set</sub> during TRIP)
Bit 8 → OVP	1 : Power Max; Power Out > 0.11W
Bit 9 → OVT	1: TEMP > 105°C
Bit 10 → DIS	1 : Ch disabled (REMOTE Mode and Switch on OFF position)
Bit 11 → KILL	1 : Ch in KILL via front panel
Bit 12 → ILK	1 : Ch in INTERLOCK via front panel
Bit 13 → NOCAL	1 : Calibration Error
Bit 14, 15 → N.C.	

## MONITOR commands related to the module

The following table shows the strings to be used to handle monitor commands related to the module.

String	Function (Units)
\$BD:xx,CMD:MON,PAR:BDNAME	Read out module name ( N1419 )
\$BD:xx,CMD:MON,PAR:BDNCH	Read out number of Channels present ( 1, 2, 4 )
\$BD:xx,CMD:MON,PAR:BDFREL	Read out Firmware Release ( XX.X )
\$BD:xx,CMD:MON,PAR:BDSNUM	Read out value serial number ( XXXXX )
\$BD:xx,CMD:MON,PAR:BDILK	Read out INTERLOCK status ( YES/NO )
\$BD:xx,CMD:MON,PAR:BDILKM	Read out INTERLOCK mode ( OPEN/CLOSED )
\$BD:xx,CMD:MON,PAR:BDCTR	Read out Control Mode ( LOCAL / REMOTE )
\$BD:xx,CMD:MON,PAR:BDTERM	Read out LOCAL BUS Termination status ( ON/OFF )
\$BD:xx,CMD:MON,PAR:BDALARM	Read out Board Alarm status value ( XXXXX )

### Meaning of Board Alarm bits

Bit	Function
Bit 0 → CH0	1 : Ch0 in Alarm status
Bit 1 → CH1	1 : Ch1 in Alarm status
Bit 2 → CH2	1 : Ch2 in Alarm status
Bit 3 → CH3	1 : Ch3 in Alarm status
Bit 4 → PWFAIL	1 : Board in POWER FAIL
Bit 5 → OVP	1 : Board in OVER POWER
Bit 6 → HVCKFAIL	1 : Internal HV Clock FAIL ( $\neq 200 \pm 10\text{kHz}$ )

### SET commands related to the Channels

The following table contains the strings to be used to handle set commands related to the Channels. The 'X' in the Field 'Channel' can be set to the '0..(N-1)' values.<sup>7</sup> When 'X=N' the command is issued to all Channels.

String	Function (Units)
\$BD:xx,CMD:SET,CH:X,PAR:VSET,VAL:XXXX.X	Set VSET value
\$BD:xx,CMD:SET,CH:X,PAR:ISET,VAL:XXXX.XX	Set ISET value
\$BD:xx,CMD:SET,CH:X,PAR:MAXV,VAL:XXXX	Set MAXVSET value
\$BD:xx,CMD:SET,CH:X,PAR:RUP,VAL:XXX	Set RAMP UP value
\$BD:xx,CMD:SET,CH:X,PAR:RDW,VAL:XXX	Set RAMP DOWN value
\$BD:xx,CMD:SET,CH:X,PAR:TRIP,VAL:XXXX.X	Set TRIP time value
\$BD:xx,CMD:SET,CH:X,PAR:PDWN,VAL:RAMP/KILL	Set POWER DOWN mode value
\$BD:xx,CMD:SET,CH:X,PAR:IMRANGE,VAL:HIGH/LOW	Set IMON RANGE value <sup>8</sup>
\$BD:xx,CMD:SET,CH:X,PAR:ON	Set Ch ON
\$BD:xx,CMD:SET,CH:X,PAR:OFF	Set Ch OFF

### SET commands related to the module

String	Function (Units)
\$BD:xx,CMD:SET,PAR:BDILKM,VAL:OPEN/CLOSED	Set Interlock Mode
\$BD:xx,CMD:SET,PAR:BDCLR	Clear alarm signal

<sup>7</sup> N is the number of channels

<sup>8</sup> parameter 'IMRANGE' can be changed only on modules featuring IMON zoom (optional)

## 4. Internal Settings

### Polarity selection

The output polarity is independently selectable for each channel. Note that the polarity is indicated by two LEDs for each channel on the front panel.

In order to change the polarity:

- Wear Antistatic Gloves
- Switch off the unit
- Wait for the complete discharge of the capacitors.
- Lay down the unit, right side up
- Remove screws 1, 2, 3, 4, 5, 6, see figure (red):

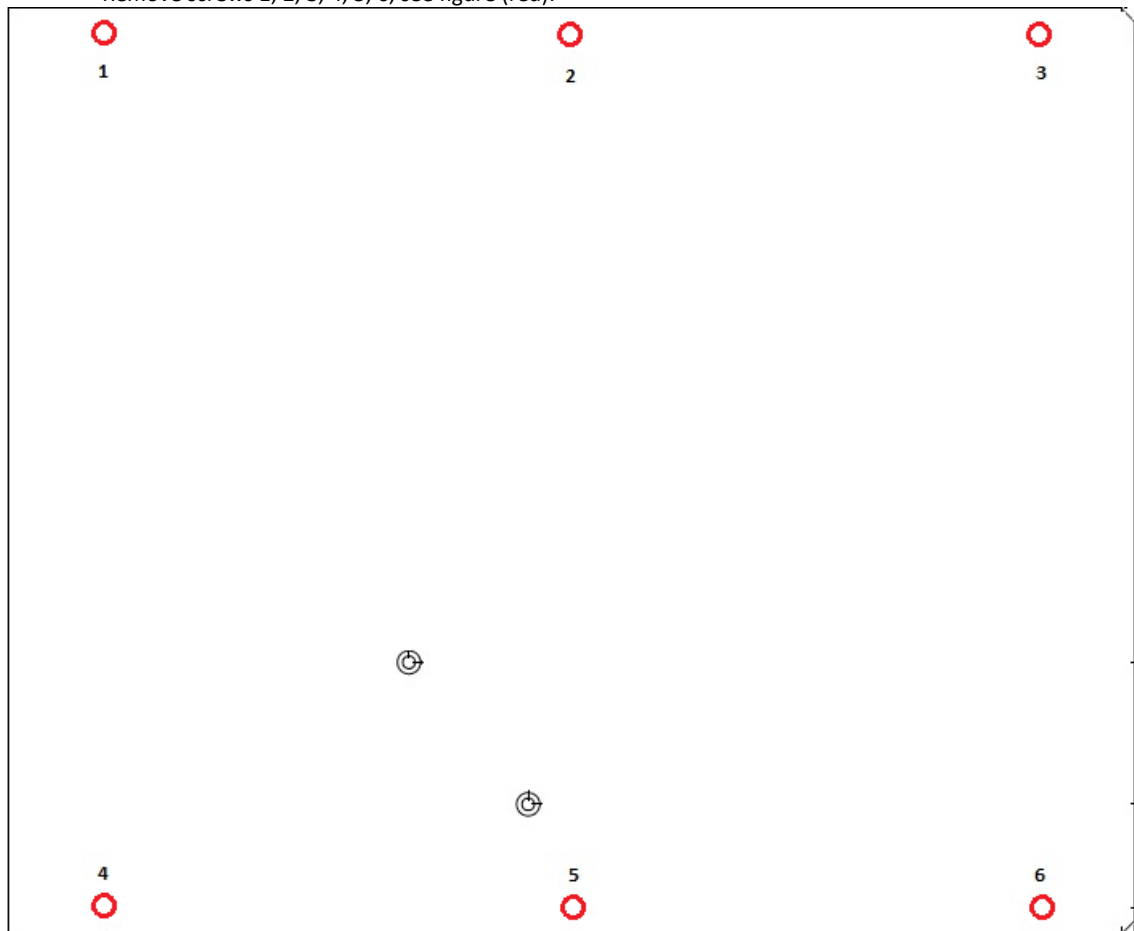
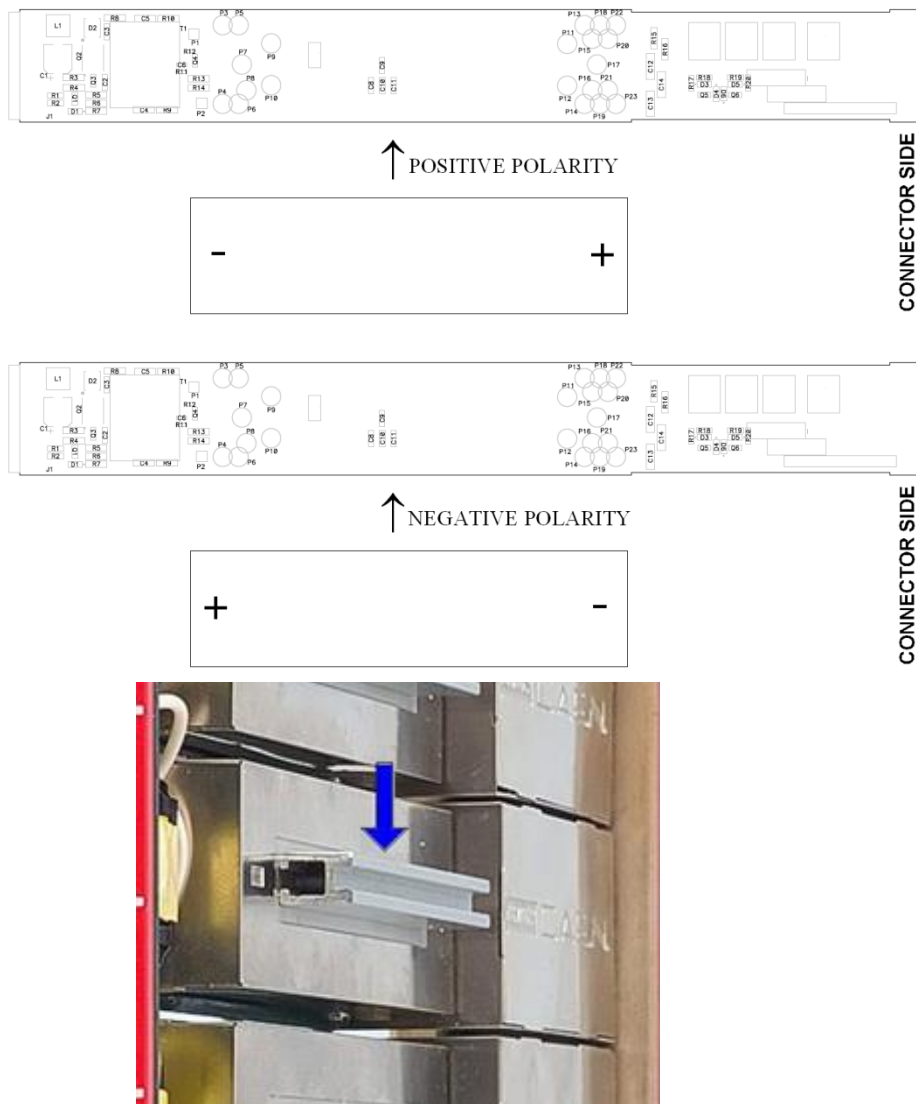

Fig. 56: Side cover removal instructions

- Lift the side cover gently
- At this point it is possible to change the channel polarity: refer to the following figure (the blue arrow indicates diode bridge box placed to configure channel as POSITIVE).
- During this operation pay attention not to bend the pins, as they are plugged completely in their sockets



**Fig. 57: Polarity selection instructions**

- In order to choose the POSITIVE POLARITY, plug the diode bridge box, with the + symbol towards the connector side.
  - In order to choose the NEGATIVE POLARITY, plug the diode bridge box, with the - symbol towards the connector side.
  - Always pull and plug the diode bridge box by holding it on the handle pointed by the arrow in Fig. above.
- Once settings are done, put the right side cover back in place with screws 1, 2, 3, 4, 5, 6.

## Internal switches

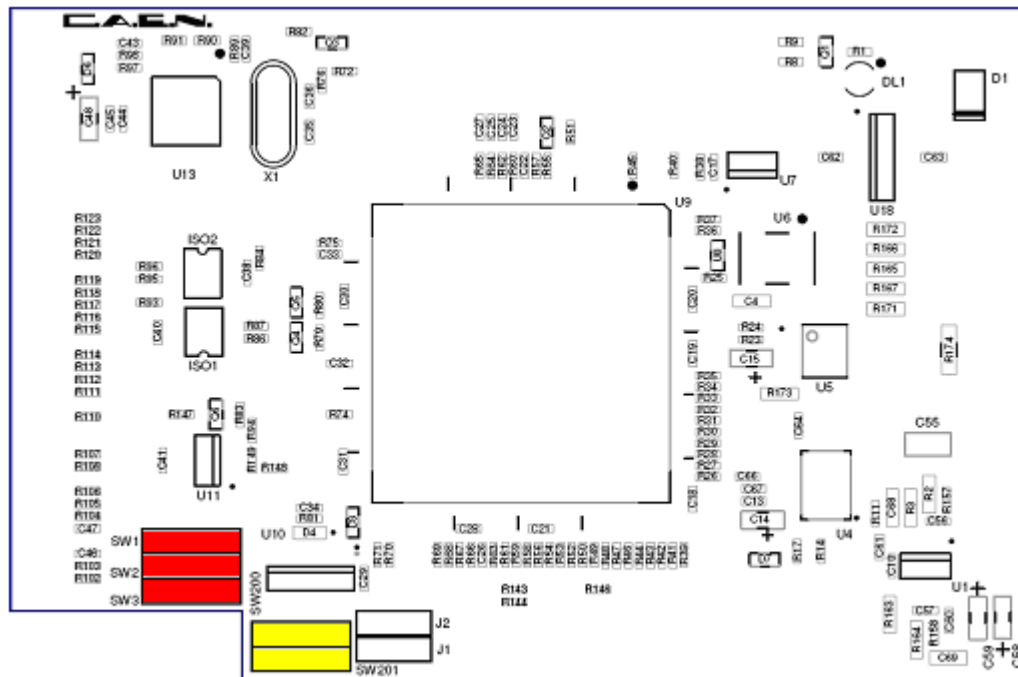

Fig. 58: Dip switch position

### Local Bus termination

The SW[1..3] switch placed on the Microcontroller board inside the module (behind the *Remote communication control section*, see p. 13), allows to terminate the Local Bus for daisy chain purposes (see p. 25); dot NOT visible = Termination ON.

### RS485 – RS232 conversion

The SW[200, 201] switch placed on the Microcontroller board inside the module, allows to adapt RS485 signals to RS232; dot visible = Adaptation ON.

## Grounding specifications

The Mod. N14xx channels share a common floating return (FAGND), insulated from the crate ground (AGND). This feature allows on-detector grounding, thus avoiding loops which may increase noise level. FAGND and AGND may be connected, by short circuiting C21 jumper pins on the motherboard (see figure below). The protection shield must be screwed off in order to access C21 (see p.35).

Please note that older versions of the N14xx may not have C21 jumper installed; contact [info@caen.it](mailto:info@caen.it) for details.

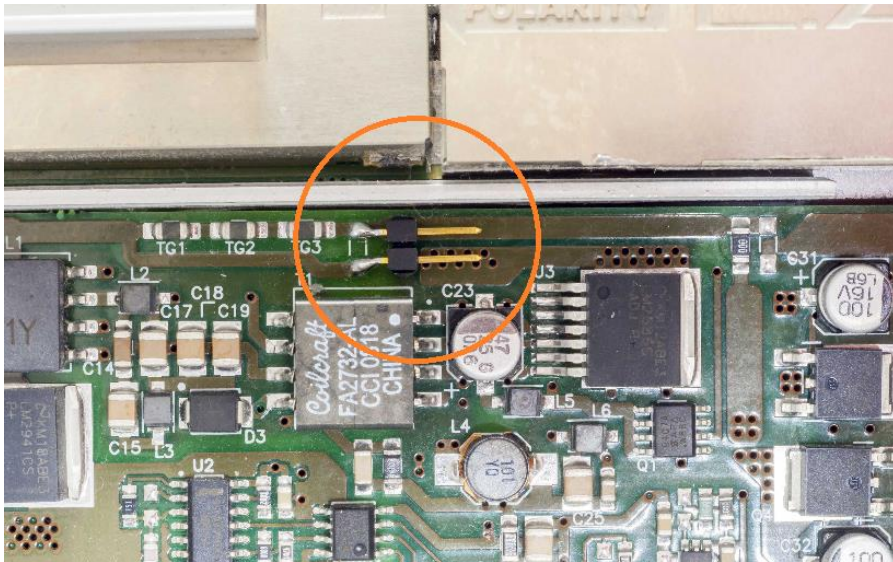

Fig. 59: C21 jumper location

## Safety Earth connection

The connection of return to Earth is fundamental for User safety. The connection must always be at the level of detector or power supply system.

Return connection even if not present or performed incorrectly, due to protection circuits implemented on the N14xx are bound to Earth; in this case the voltage difference between return and Earth (System), is limited to approximately 50V. Please note that this is a status of emergency-protection, not a working one. The Connector Configurator allows to optimize the connection of the return and of AGND (Earth). The best configuration must be determined by the user upon application, the optimal connection depends on many characteristics of the related experiment.

The following diagrams show two examples of configuration, namely:

The “closed loop “ Earth configuration (C21 contacts closed)

The “open loop” Earth configuration (C21 contacts open)

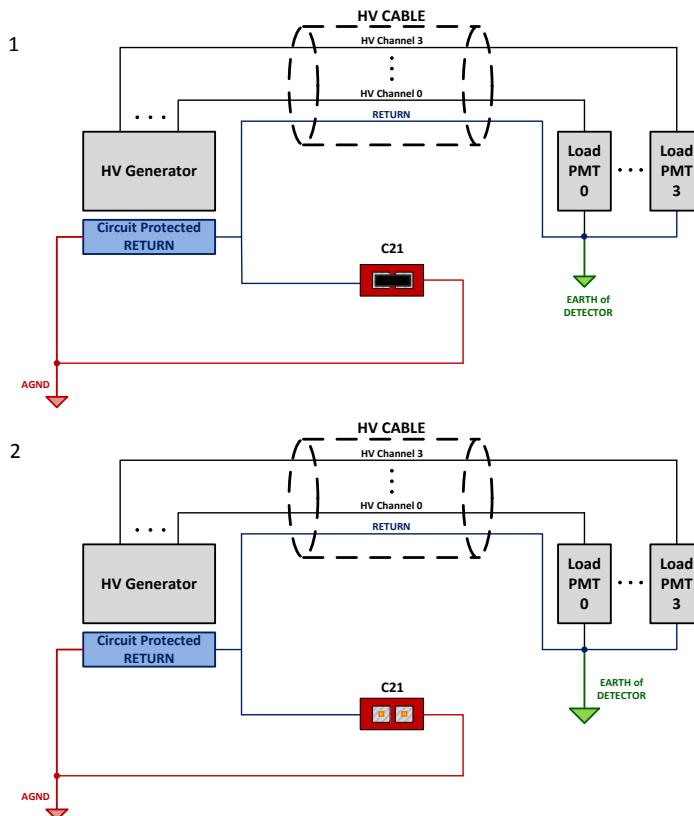

Fig. 60: Earth configuration connection examples



CAEN SpA is acknowledged as the only company in the world providing a complete range of High/Low Voltage Power Supply systems and Front-End/Data Acquisition modules which meet IEEE Standards for Nuclear and Particle Physics. Extensive Research and Development capabilities have allowed CAEN SpA to play an important, long term role in this field. Our activities have always been at the forefront of technology, thanks to years of intensive collaborations with the most important Research Centres of the world. Our products appeal to a wide range of customers including engineers, scientists and technical professionals who all trust them to help achieve their goals faster and more effectively.

**CAEN S.p.A.**

Via Vetraia, 11  
55049 Viareggio  
Italy  
Tel. +39.0584.388.398  
Fax +39.0584.388.959  
info@caen.it  
www.caen.it

**CAEN GmbH**

Eckehardweg 10  
42653 Solingen  
Germany  
Tel. +49.212.2544077  
Mobile +49(0)15116548484  
Fax +49.212.2544079  
info@caen-de.com  
www.caen-de.com

**CAEN Technologies, Inc.**

1140 Bay Street - Suite 2 C  
Staten Island, NY 10305  
USA  
Tel. +1.718.981.0401  
Fax +1.718.556.9185  
info@caentechnologies.com  
www.caentechnologies.com