

MAROC: Multi-Anode ReadOut Chip

P. Barrillon, S. Blin, T. Caceres, M. Heller, C. de La Taille, P. Puzo, N. Seguin-Moreau

Laboratoire de l'Accélérateur Linéaire, 91898 Orsay, France

Corresponding authors: barrillo@lal.in2p3.fr & blin@lal.in2p3.fr

Abstract

MAROC is the readout chip designed for the ATLAS luminometer made of Roman pots. It is used to readout 64 channels multi-anode photomultipliers and supplies 64 trigger outputs and a multiplexed charge output. The second version of this ASIC was received during summer 2006. It has been thoroughly tested at LAL since. This paper presents the results obtained and shows that the performances were found in agreement with the main requirements.

I. INTRODUCTION

MAROC stands for Multi-Anode ReadOut Chip. It has been designed to readout 64 channels photomultipliers from Hamamatsu used by the ATLAS Luminometer [1]. This chip is an evolution of OPERA_ROC ASIC installed on the OPERA experiment [2].

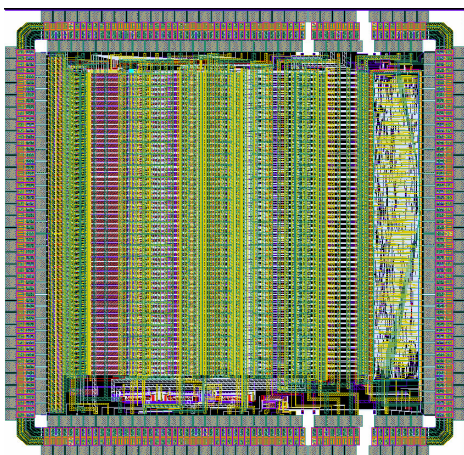

Figure 1: MAROC second version layout.

Figure 1 represents the layout of MAROC second version, called MAROC2. Few changes have been performed and problems corrected with respect to the first version [3] which already showed a nice global behaviour.

The performances of MAROC were checked thanks to characterisation tests performed with a dedicated test board developed at LAL. The results obtained are presented in this paper after a short description of the applications that will use MAROC and a detailed presentation of the ASIC.

A. Applications

The main application that will use MAROC is the ATLAS luminometer. It is made of Roman Pots (RP). They consist in

0.5mm² scintillating fibers arranged in 10 planes in the U and V directions. Each plane is composed by 64 fibers. The light produced is then collected by multi-anode photomultiplier tubes H7546 from Hamamatsu [4], that will run at 800 to 950 V which corresponds to a gain of 3.10^5 to 2.10^6 . These PMTs have an important non-uniformity that has to be corrected either by applying a different high voltage to each channel or by amplifying the output signal with different factors for each channel. This second option is the one selected because of MAROC features (see next section). Figure 2 shows a schematic of a Roman Pot and the front end electronic. In total eight RPs, equipped with about 200 chips, will be installed at 240m from the ATLAS interaction point. The whole readout system of ATLAS luminometer is presented in this paper [5].

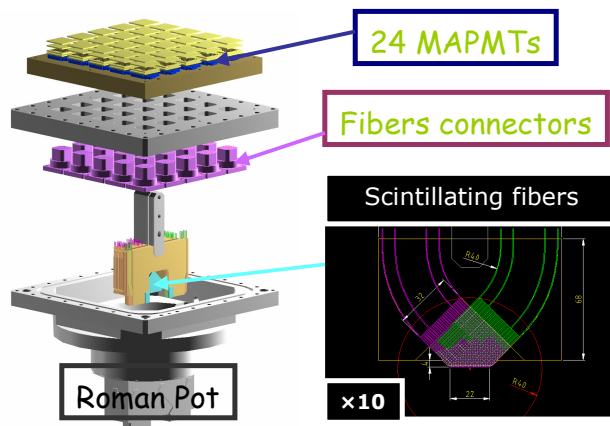

Figure 2: Schematic of a Roman Pot of the ATLAS luminometer.

Other applications using PMTs or silicon PMs, like medical imaging and neutrino experiments, might also use dedicated versions of MAROC.

B. The ASIC MAROC

1) Main features

The second version of MAROC chip [6] is a 64-channel input front end circuit based on AMS Si-Ge 0.35 μm technology and developed with a CQFP240 package. It is 16 mm² (4 mm \times 4 mm) wide and functions with 3.5V power supply. Its power consumption is around 350 mW.

The block diagram of the ASIC is given in Figure 3. For each one of the 64 channels, the PM signal is first amplified thanks to a variable gain preamplifier which has low noise and low input impedance (super common base inputs) to

minimise crosstalk. It allows compensating for the PM gain dispersion up to a factor 4 to an accuracy of 6% with 6 bits.

The amplified current feeds then a slow shaper combined with two Sample and Hold buffers to store the charge in 2pF and provide (5 MHz) an analog and digital multiplexed charge output up to 5pC. A second S&H has been added with respect to the first version of the ASIC in order to allow the measurement of both the baseline and the maximum of the signal. The digital charge output is provided by a 12 bit ADC Wilkinson.

In parallel, 64 trigger outputs are produced via fast channels made of a fast (15 ns) shaper followed by three discriminators. There are two kinds of fast shaper: bipolar and unipolar that are respectively the back-up and principal choice.

The discriminator thresholds are set by an internal 10 bit DAC, made of a 4 bit thermometer DAC for coarse tuning and a 6 bit mirror for fine tuning. They have respectively steps of 200 and 3 mV per bit.

The trigger outputs correspond either to the response of a single discriminator (DAC1) or to an encoded response from the three DACs.

An additional feature has been implemented: the sum of up to seven preamplifier outputs.

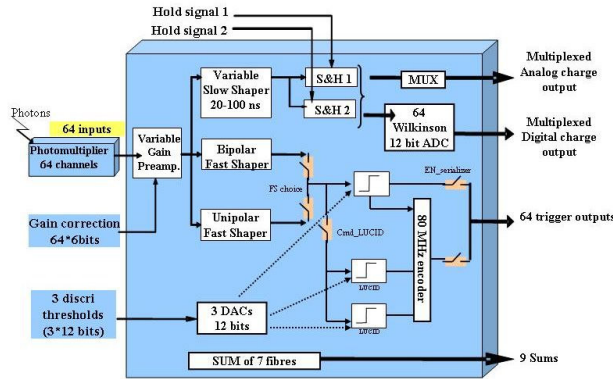

Figure 3: Block diagram of MAROC second version.

2) Requirements

The main requirements concerning MAROC are the following:

- A 0-4 variable gain preamplifier in order to correct for the PM non uniformity.
- The trigger efficiency must reach 100% for a signal larger than 1/3 of photoelectron (pe), which corresponds to a charge of 50 fC for a PM functioning at gain 10^6 (900 V).
- A charge measurement up to 30 photoelectrons with a linearity of 2% or better
- A cross talk of 1%
- A noise of 2 fC

The results of the characterisation tests carried out to check these specifications are presented in the next section.

II. CHARACTERISATION TESTS

A. Laboratory test set-up

The test board developed at LAL in order to perform the characterization tests is showed on Figure 4. This top view exhibits the principal elements: the MAROC chip in its package, the control FPGA (Altera), the USB port and the 64 channels PM socket.

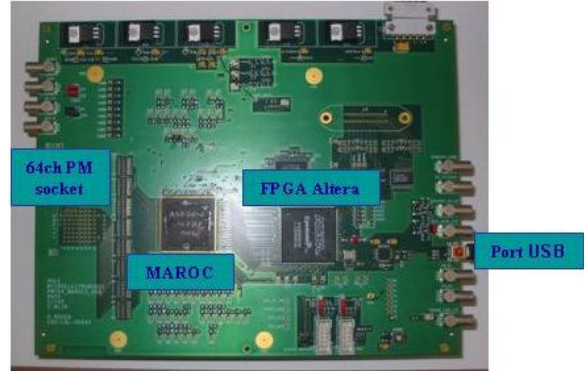

Figure 4: Picture of the test board used for characterisation tests.

In addition to the test board and the control PC, other equipments were used: a pulse generator to provide the input signal through a 10 pC capacitor, a voltmeter and an oscilloscope in order to visualize the charge or trigger outputs.

The board and the other elements of the set-up were controlled through LabVIEW software [7] via USB and GPIB respectively. A complete set of tests was available to check MAROC performances [8]. The data analysis was performed mainly with Igor, PAW and ROOT software [9].

B. Performances

1) Pedestals

Figure 5 represents the distribution of the slow and fast shaper pedestals for the 64 channels of the tested ASIC. The dispersion was found less than 1 ‰ for the three shapers.

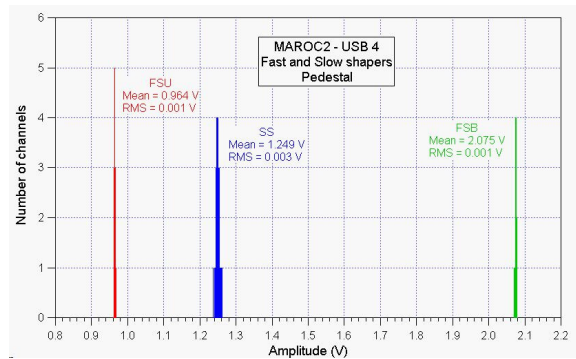

Figure 5: Distributions of fast and slow shapers pedestals (FSU: fast shaper unipolar, FSB: fast shaper bipolar, SS: slow shaper).

A really low variation of less than 1 ‰ was found on a day to day basis for all shapers proving the nice stability over time of the pedestals.

2) DAC linearity

The linearity was checked by scanning the thermometer and mirror DACs and measuring the signal for each combination. Figure 6 gives the evolution of the signal amplitude (V_{DAC}) as a function of the thermometer-mirror combination, the thermometer varying from 0 to 12 and the mirror from 0 to 255. By fitting this line in the region without saturation (up to thermometer = 10), we obtained a nice linearity of $\pm 1\%$ on a large range. The two other discriminators showed similar behaviours.

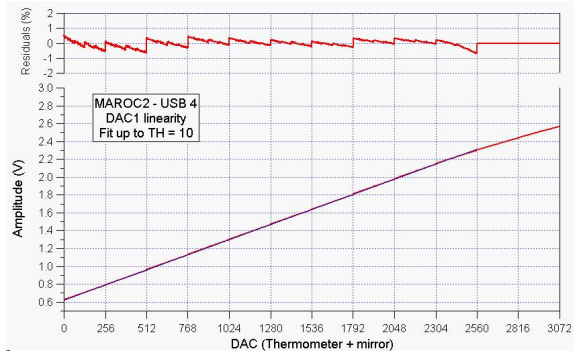

Figure 6: DAC linearity of the first discriminator.

3) Trigger output

Well known S-curves were also studied. They correspond to the measurement of the trigger efficiency during a scan of the input charge or the threshold while the other parameters, like the preamplifier gain, are kept constant.

Figure 7 represents the trigger efficiency as a function of the input charge for the 64 channels of a single chip. All channels were set at gain 1 and the threshold was fixed at $V_{dac}=1.35\text{ V}$. We obtained 100 % trigger efficiency for an input charge of approximately 50 fC which corresponds to 1/3 pe- as requested.

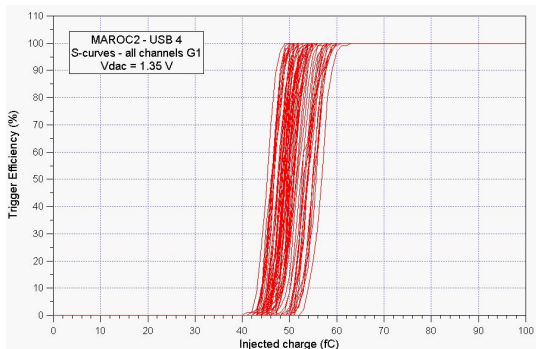

Figure 7: Trigger efficiency of the 64 channels of a chip as a function of the injected charge for a fixed threshold of 1.35 V, also called S-curves.

Figure 8 shows the evolution of the 50% trigger efficiency input charge as a function of the channel number. The mean value and rms are respectively 50.06 and 2.85 fC leading to a reasonable dispersion of 5.6 %, taking into account that no gain tuning was performed to reduce it.

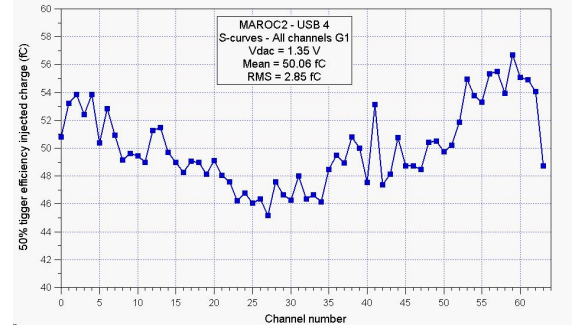

Figure 8: 50 % trigger efficiency input charge versus the channel number.

The effect of the threshold on these s-curves was studied by looking at them on selected range of the DAC. S-curves were recorded for a single channel for 60 different DAC values. Figure 9 represents the evolution of the 50 % trigger efficiency input charge as a function of the applied threshold. A low linearity less than $\pm 1\%$ was obtained.

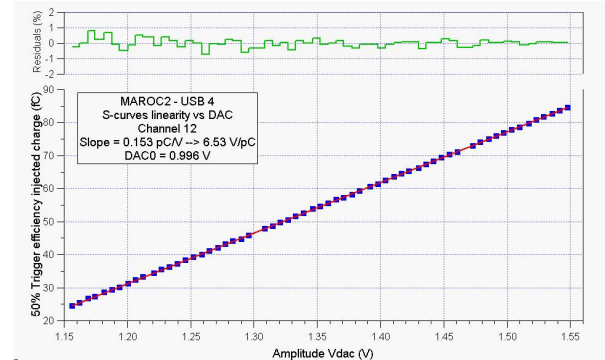

Figure 9: 50 % trigger efficiency input charge versus applied threshold for a single channel and a fixed preamplifier gain of 1.

Figure 10 gives s-curve examples for different preamplifier gains (from 0.4 to 4). At high gain, the 100 % trigger efficiency is reached at less than 15 fC which corresponds to 1/10 of photoelectron for a MAPMT gain of 10^6 .

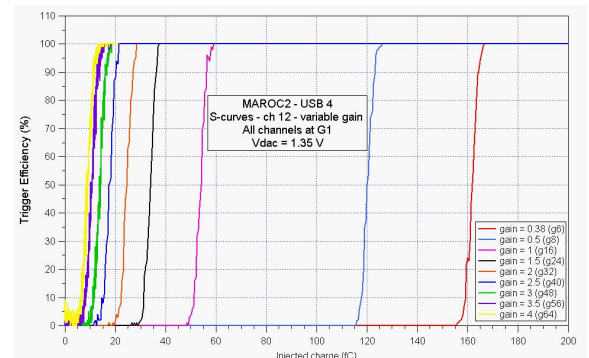

Figure 10: Single channel S-curves versus injected charge for nine different preamplifier gains.

Figure 11 represents the trigger efficiency as a function of the applied threshold for four different injected charges; for a single channel. The linearity of the 50 % trigger efficiency threshold versus the charge was found close to 1 %.

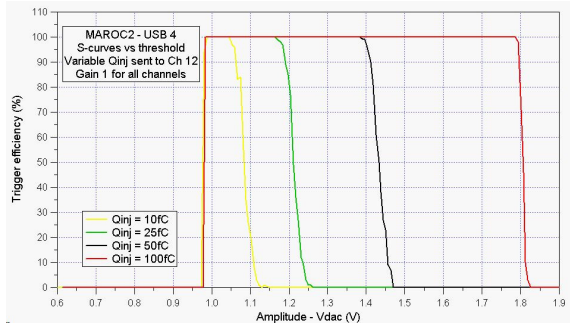

Figure 11: Trigger efficiency as a function of the threshold applied for 4 different injected charges.

4) Charge output

Waveforms were recorded with a fixed injected charge of 100 fC and for variable preamplifier gains as one can see on the Figure 12 which represents the amplitude as a function of the time for seven different gains. At gain $G=1$ the amplitude is 17 mV. This corresponds to 25.5 mV/pe for a MAPMT gain of 10^6 .

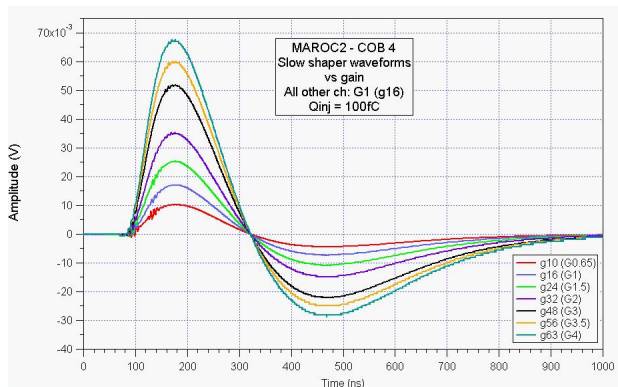

Figure 12: Slow shaper waveforms for a fixed injected charge of 100 fC and seven different preamplifier gains.

From these measurements the linearity of the charge output as a function of the gain was calculated to be around $\pm 1\%$.

5) Cross-talk

In order to study the cross talk, a variable signal was sent to a central channel (8 in our example) and output trigger from this channel and the two neighbours (7 and 9) was recorded. The threshold was set in order to get 100 % trigger efficiency at 50 fC for the central channel. The maximal signal delivered was 10 pC and the gain was 1 for all channels.

Figure 13 represents the s-curves obtained for the three channels, on the full input charge range ([0-10] pC). No trigger signals were seen before 1.7 pC for the two neighbouring channels leading to a cross talk smaller than 3%, a bit larger than what is expected. These measurements were performed for the 64 channels of the tested chip and the cross-talk calculated was always of this order (2-3 %). For understanding the s-curves of the channels 7 and 9 are also given for three other preamplifier gains (0.75, 0.5 and 0.25) on the Figure 13. As one can see the cross-talk is sensitive to

the variation of the gain which means that it comes from the test board or the preamplifier since the gain is applied at an early stage of the ASIC.

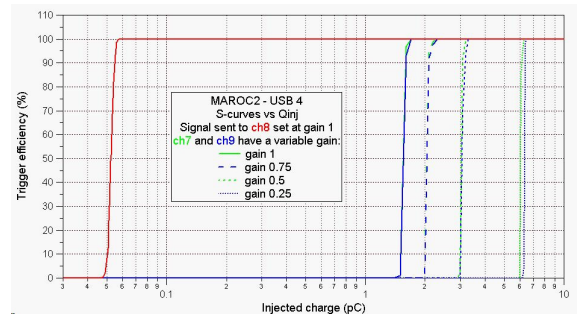

Figure 13: S-curves for channel 9 at gain 1 and its two neighbours for four different gains in the range [0.25, 1].

Even if the cross-talk is larger than expected, we can be confident by the fact that it only appears above large values of injected charge. Figure 14 gives the distribution of the injected signal, in photo-electrons, for which cross-talk appears for 64 channels. For most of them this signal is greater than 10 photo-electrons, which correspond to the queue of the distribution expected for the scintillating fibers used by ATLAS luminometer. Indeed the expected signal from the fibers is supposed to be Poisson distributed, with a mean at 3 to 5 p.e depending on the type of fiber. By convoluting the Poisson distribution with the s-curve of each channel and looking at the ratios of the integrals we obtained a more physic approach of the cross-talk with an average value closer to the requirements (1 %).

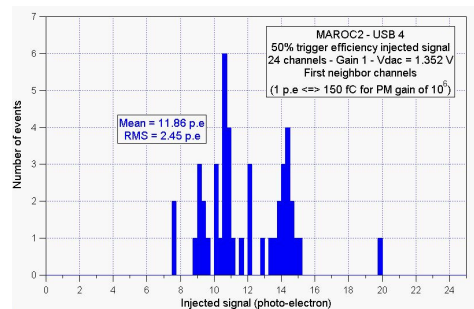

Figure 14: Injected signal for which cross-talk appears.

We also looked at the cross-talk on the slow shaper path. Figure 15 represents the waveforms of the channel 8 and its neighbours for an injected charge of 2 pC. The amplitude of the channels 7 and 9 is multiplied by 100. The calculation of maximum ratio gave a cross-talk of less than 1%.

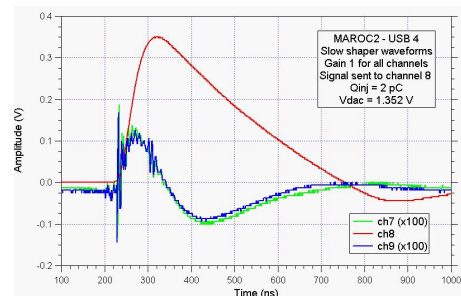

Figure 15: Slow shaper waveforms for channel 8 and its two neighbours for an injected charge of 2 pC on the central channel.

III. CONCLUSIONS

Most of the tests carried out have showed improved performances with respect to the first version of MAROC. Thanks to a better separation the substrate coupling has disappeared and now all channels can be run at the same time at maximal gain without oscillations. The cross-talk is a bit larger but appears only for really high signals (>10 p.e) and low threshold ($1/3$ p.e).

All the characteristics tested so far have matched the requirements. This will allow the use of MAROC2 chip during beam tests at the end of 2007. These tests should be performed on a full Roman Pot prototype equipped with the last version of the PMF (Photo Multiplier Front End). Figure 16 shows the first version of the PMF used in 2006 test beam. It consists in a photomultiplier and three PCBs: the HV board, a passive board and an active one. This board comprises a FPGA and the MAROC bonded directly on the PCB.

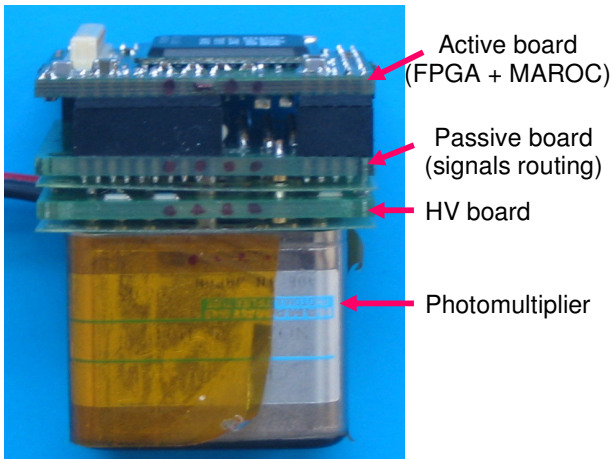

Figure 16: First version of the PMF.

The results from these future beam tests added to the ones obtained in laboratory will lead to the design of the last version of the chip and the final production of 200 ASICs and PMFs early 2008.

REFERENCES

- [1] ATLAS Collaboration, *ATLAS Forward Detectors for Measurement of Elastic Scattering and Luminosity Determination*, Technical Design Report, CERN/LHCC/2007-xxx
- [2] A. Lucotte et al., *A front-end read out chip for the OPERA scintillating tracker*. Nucl. Instr. And Meth. A521 (2004) 378-392
- [3] P. Barrillon et al., *MAROC: Multi-Anode ReadOut Chip for MAPMTs*, proceedings of 2006 IEEE conference.
- [4] Hamamatsu web site, PM H7546B datasheet.
- [5] G. Blanchot et al., *System Design of the ATLAS Absolute Luminosity Monitor*, proceedings of TWEPP07 conference.
- [6] P. Barrillon et al., *64-channel Front-End readout chip – MAROC* datasheet.
- [7] LabVIEW web page: <http://www.ni.com/labview/>
- [8] P. Barrillon et al., *MAROC2 Labview software manual – USB version 3*, April 2007.
- [9] Igor Pro, web site: <http://www.wavemetrics.com/>
Paw software web site: <http://paw.web.cern.ch/paw/>
ROOT software web site: <http://root.cern.ch/>